

\$2.00

# International Color Computer Club, Inc.

Newsletter Volume 2 #4

NON-PROFIT CORP. FOR EDUCATIONAL PURPOSES

## COLOR COMPUTER

**QUESTIONS**

**REVIEWS**

**LETTERS**

**NEWS**

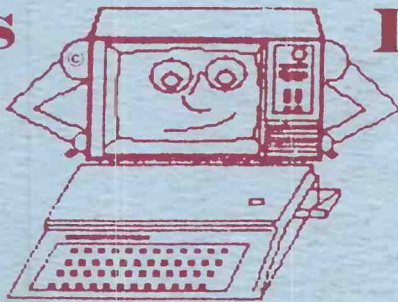

**DISCOUNTS**

**PROGRAMS**

**ARTICLES**

**ANSWERS**

**TRS-80C ● MC-10**

*HARDWARE ISSUE*

**JULY/AUGUST 1983**

**WORLDWIDE MEMBERSHIP**

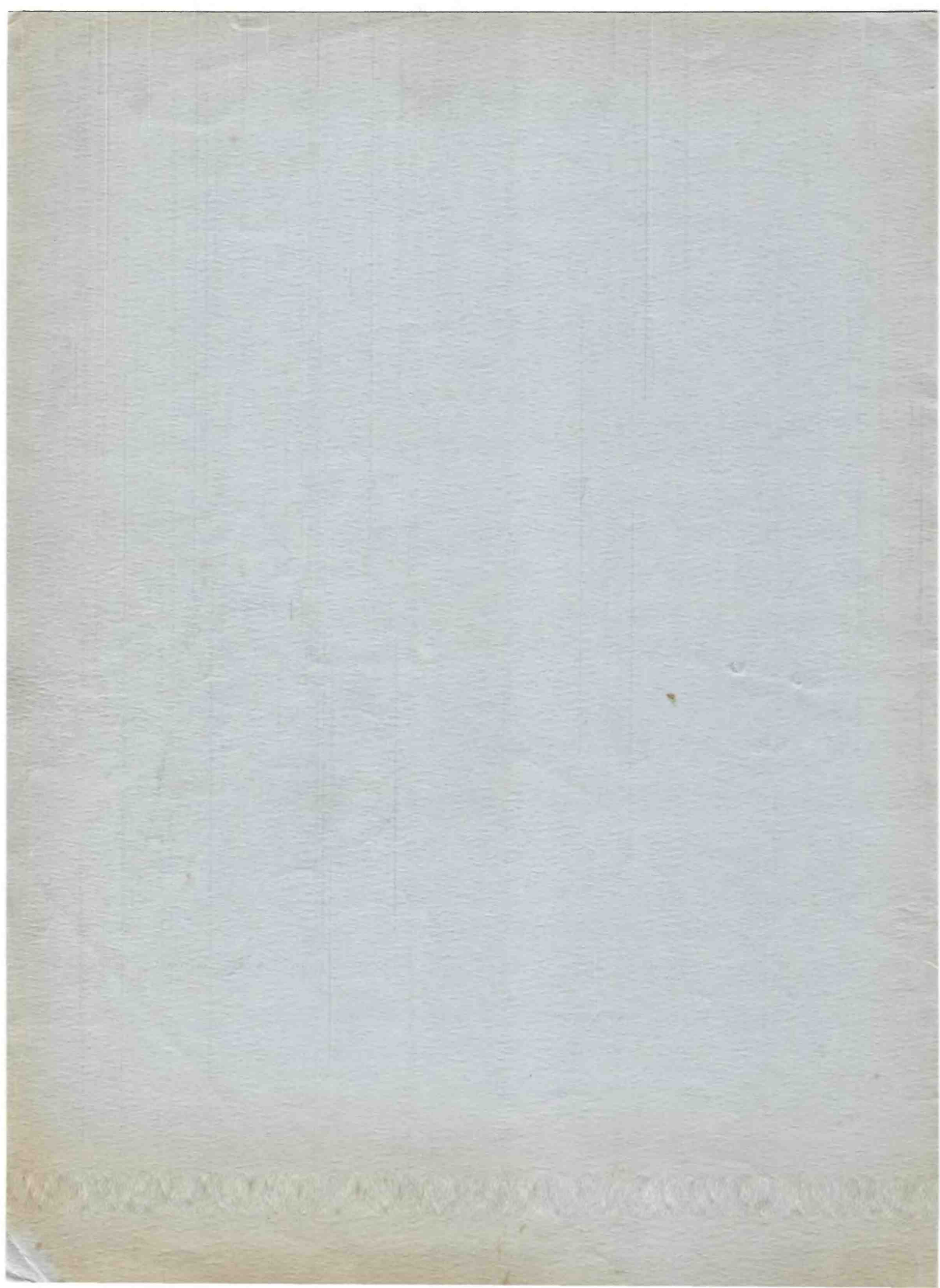

# DISCOUNTS AVAILABLE

Note: On any order which you send in direct, be sure to include your membership number. If you send your order to us, make your check payable to us. If it says send order to us, PLEASE do not try to order direct

## ORDER DIRECT COMPANIES

Britt Monk, CDP (use special form in this newsletter) You will receive a 20% to 50% rebate from the club.

Color Software Services 5% Off

Color Software Services 5% Off

Computer Island 20% Off on Software & \$1.00 Off on Book (A Byte of Color Basic)

Family Computers  
\$15-\$50 Deduct 5%, \$50-\$100 Deduct 10%, \$100-\$150 Deduct 15%, \$150 and up Deduct 20%

HARMONYCS 10% Off on Software

HAWG Wild Software 10% Discount

Leader Sales Corp. 20% Off

MICRO-DOC 15% Off of a Book

PCLEAR4co. 25% Off on All Product

PCLEAR-90 Software 10% Off on All Software & Joysticks

S & S Arcade Supplies  
10% Off on All Hardware, 20% Off  
10% Off on All Hardware, 20% Off  
on "Shell" Software, 10% Off on  
Other Software

Sugar Software 10% Off on all Software

\*\*\*\*\*  
\*\*\*\*\*  
\*\*\*\*\*

## SEND ALL OF THESE ORDERS TO US

Chromasette Magazine \$5.00 Off of Regular Subscription Rates

Color Computer News \$3.00 Off of Regular Subscription Rates.

Color Computer Weekly SEE ADVERTISEMENT

DSL Computer Products 25% Off on all software

Hawkes Research Services 20% Off on GRAFLOT Program

Moses Engineering 20% Off on all software

Radio Shack 10% Off on any Radio Shack Product except Microcomputer News

the RAINBOW Magazine 25% Off of Regular Subscription Rates

Spectral Associates Software Only  
10% Off on orders less than \$50.  
25% Off on orders more than \$50.  
(Be sure and include the 3% for Shipping & Handling)



## NOTICE TO ALL MEMBERS\*\*\*\*\*

The following is not a review, or a program, or an article it is a plea for help!! That is right we said HELP. The reason we need help is because the little space that I am writing this in needs to be filled with something so we can get this newsletter to the printer in time for you to receive it by the Voting date. We fiddled around and finally decided that we would try again for a (continued on page 2)

# INDEX

ARTICLES	Page #	PROGRAMS	Page #
Power Problems/Fixes by Gary Smith..	6	CASSETTE LABEL PRINTER by Gerry Schechter	13
<u>POPPING KEY FIX</u> by Jim DeStafeno	9	LOTTO - Daily Number by	15
TAPE I/O FIX by Leslie Green.....	20	TellTime by Gil Letellier.....	18
Harware Upgrades & Info by Bob Rosen.....	21	RIFLE Recoil by Ron Garrett.....	28
TRS-80 MUSIC by Patrick O'Shaughnessy	22	SEE by Paul Schallowitz.....	38
RAINBOWfest by Don H. Garrett....	27	COPYCAMR by Joseph Songer.....	56
REVIEWS by Ron Garrett.....	28	CAMERA by Joseph Songer.....	69
Revision "F" 64K Upgrade by Gary Smith.....	36	MISCELLANEOUS	
<u>COLOR COMPUTER DISPLAY INTERFERENCE</u> by J.W. Porter.....	41	DISCOUNTS AVAILABLE.....	1
Affiliation with the ICC, Inc. by Ron Garrett.....	45	EDITORIAL.....	3
COPYCAMR by Joseph Songer.....	55	Newsletter Statement.....	4
Off the Shelf by Ron Garrett.....	53	Secretarial Report.....	5
REVIEWS		LETTERS TO THE CLUB <sup>29,30,43,54,&amp;55</sup>	
RAINBOW WRITER by C.L. Pilipauskas	11	Back Issues.....	33
FIRECOPTER by Ron Woerner.....	20	Reasons to Join.....	37
Color Graphics Editor by Stan Saunders.....	24	New Product Releases & News Releases..... <sup>47, 48, 57,&amp; 58</sup>	58
Color Caterpillar by Mike Hall...	25	ICCC, Inc. Library.....	49
MC-10. A Toy ?? by Ron Garrett...	26	Items to be Voted ON.....	51
PRINTER vs. MARRIAGE by Dan Curtin.....	34	VOTING RESULTS.....	51
VIDEO Plus Review by Frederick Boyd	70	Disk Color Basic Word Search	59
The NEW TRS-80 Micro Color Computer by Linda Miller.....	74	RULES & BY-LAWS Of ICC, Inc.	60
		MINUTES of the First Board of Directors Meeting.....	71
		Affiliation Document.....	75
		Classified Advertisements ..	78

(continued from page 1)  
 few little pieces of information to fill spaces like these. If you have a gripe about the club, BBS, or anything about the CoCo or the MC-10 or the TDP-100 or the Dragon 32 or Tandy Corporation in

general just write to us stating that you wish to have this little tid-bit of information published in the newsletter to fill our little small spaces. You can send us a picture of your system or a  
 (continued on page 17)

# EDITORIAL

Well, hello members. Did you miss my editorial last month? Last issue we were holding a vote for the directors of this corporation and every time I tried writing the editorial, I wound up sounding like a campaign for certain people who were nominated for the board. I really didn't think that was fair, since the other people who were nominated for the board didn't have a chance to say anything for themselves. As a result, I just didn't write anything. But now that the voting is over, I will continue to write my editorial, and the first order of business is to thank all of you for electing me to the board.

All of you who know me, know that I have my computer built into this monster of a chair (which I built) and I have recently redesigned my chair (this was another reason that I didn't write an editorial for the last issue, my computer was down). With better organization perhaps I can now be more efficient and more productive. It seems that I am among the few who write programs for the club which are probably good enough to sell. Speaking of programs, my Accounts Receivable Disk, (the 2 Disk version) has been re-worked and is yours for the asking. I would like to get one of you to write a review on the program and help document it for other members. Any volunteers??

This club is getting bigger and better all the time. We are getting more and better discounts for the members and are offering more for your money now than ever before. As a case in point, we had a man down from Arkansas that joined up with us, and before he even left the office, he had saved more than his membership fee in discounts for products

he ordered. We will continue to work for more (and bigger) discounts for you, and try to increase the size and quality of the newsletter. Speaking of the newsletter, how do you like this one? Quite an improvement, eh?

We now have a parts librarian and he will soon have a complete stock of parts (every part of CoCo) so if you need a replacement part contact him. We are still looking for technical advisors for both hardware & software. If you would like to have this position (or one of them), please send me a note.

**REQUEST:** Do any of you have a flat bed plotter you would consider renting or loaning the club for a couple of months?

**Another Request:** We badly need articles on interfacing CoCo to the outside world. Specifically, do any of you know how to build an interface which would work relays (up to 100) which may control devices with voltages from 5 v. to 110 v. Please write us an article on it if you do.

To those members who are writing programs for sale, we know you cannot donate them to the library however, you should send a copy of it to the club to be sent out for review. We will not copy it or give it to friends, etc. In fact, it will be treated just like the ones we receive from Spectral Associates, DSL, Rainbow Connection Software, and etc.

See you next issue, RON!



4<sup>th</sup> of  
July!

BLACK CAT



International Color  
Computer Club, Inc.  
Newsletter

Publisher  
John Stephens

Editor  
Ron Garrett

Assoc. Editor  
Don H. Garrett

Circulation & Advertising  
Don H. Garrett

Published Bi-Monthly  
by the International Color  
Computer Club, Inc. (c) 1983

A Non-Profit Educational Corp.

This newsletter is intended for the personal use of the members (stockholders) of the corporation and Any other use or reproduction is prohibited (Other newsletters may reprint articles of data with credit to this newsletter). TRS-80, Color Computer, The biggest name in little computers and Extended Color Basic are Trademarks of the Tandy Corporation.

The Publisher, Editor, and the Corporation assumes no responsibility for errors or omissions. Neither is any liability assumed for any damages resulting from any information contained herein or anywhere else. Please send the correspondences and subscription requests to: International Color Computer Club, Inc., 2101 E. Main St., Henderson, TX 75652.

\$2.00 per copy

1 Year Subscription Prices<sup>¶</sup>

\$10.00 in the U.S.A.  
\$15.00 in Canada & Mexico  
\$40.00 outside the USA<sup>3</sup>

Membership in the Club  
for 1 Year<sup>¶</sup>

\$30.00 in the U.S.A.  
\$40.00 in Canada & Mexico  
\$50.00 outside the USA<sup>2</sup>  
\$90.00 outside the USA<sup>3</sup>

- ¶ The above prices are in U.S. funds.
- <sup>2</sup> This is for all countries except Canada & Mexico and it is for SURFACE MAIL DELIVERY.
- <sup>3</sup> This is for all countries except Canada & Mexico and it is for AIR MAIL DELIVERY.

## RENEWING?

Check your label to be sure it's correct. For uninterrupted service include your label with your order.

## MOVING?

Please enclose your label or write your name and address as it appears on your label.

Print or Type ( <i>Last Name, First Name, Middle Initial</i> )	
OLD ADDRESS	No. and St., Apt., Suite, P.O. Box or R.D. No. (In care of)
	Post Office, State and ZIP Code
NEW ADDRESS	No. and St., Apt., Suite, P.O. Box or R.D. No. (In care of)
	Post Office, State and ZIP Code
Effective Date	If Temporary, Expiration Date
Sign Here	Date Signed
THIS ORDER PROVIDES for the forwarding of First-Class Mail and all parcels of obvious value for a period not to exceed 1 year.	I AGREE TO PAY FORWARDING POSTAGE FOR NEWSPAPERS AND MAGAZINES FOR 90 DAYS <input type="checkbox"/> NO <input type="checkbox"/> YES

# Secretarial Report

What do you think of this new issue?? I think it is great especially since it is typeset on a new Canon Daisywheel.

Let's see first off I would like to bring to your attention (if you don't already know) that the library program has been changed and you now can get 6 programs per tape, instead of one, for your \$2.00. Also we have moved the newsletters down to the library (Back issues) so that we can have some room to work in at this office. It was getting to crowded up here.

Also the voting went a little better this time with a % return of the cards. Speaking of voting I see that the classified ad passed pretty good. I am glad because there was two reasons for us to want to do this: # 1 was because it takes up less space so we can put more programs and reviews and etc. in the newsletter for you. We don't want it to look like the magazines in the since that they have 30% advertising and 70% information. We want our newsletter to be at 15% advertising and 85% information. The # 2 reason is that you can fit a classified ad into a space more convenient than you can a display ad. Right? Now if you already have a Display ad in the newsletter then you have until October 10th to replace it with a classified or to be billed for it after that date. All classifieds are subject to being retyped to the newsletter requirements.

It seems that a lot of you asked why the quality of the newsletter listings were so bad? And why there was no documentation for the programs? Well to answer both questions; the fact is that the print in the newsletter

listings is the best we had to offer. If you remember we had bought an IBM to make the listings look better it did not work right. So, we ordered a daisywheel and it finally got here two months later. As far as the documentation goes; if you can persuade the author to write the documentation before he sends the program in we will print more documentation; however, we do not have the time, staff, or equipment to test every program and make documentation for it. I guess what it boils down to is that we will have to make another qualification for sending in a program for the newsletter or the library. And that will be that unless the author supplies some sort of documentation we should have the right not to publish it or to put it in the library.

It seems the renewal kits for the renewals was a very good idea because it passed with little opposition. And what opposition it had they said that the reason they were voting no was because they did not think the New Certificate of Membership and the New Membership cards should be included. Well let me point out that the New Certificates of Membership is for membership in the corporation and that certificate and only that certificate guarantees you of having a share of stock in the corporation since the other certificates do not have Inc. (and some don't have International on them) on them. The new Membership card may not be necessary but it also has our new name on it and they only cost about \$15 a thousand.

To all of you that have renewed already I would like to thank you for your support of this  
(continued on page 20) PAGE 5

# POWER PROBLEMS/FIXES

by Gary Smith

You are drugging away, editing a program. It is a long job, and you have been at it a long time; but you are finally near the end. Suddenly, the display goes blank or fills with random patterns. You try hitting BREAK! You vainly try LIST, RUN or CONT! Nothing will bring the program back from never-never land.

You load a program in, and all seems well; but the display comes up with garbage. Or characters are randomly interchanged (typically A is now B, Q is now R...). Or a GOTO now goes to a crash.

What is going on here? How come perfectly good jobs are now full of trash? Maybe (probably) you have entered the twilight zone of power anomalies. You have been glitched!

What incoming power anomalies are, and how to minimize the disasters they create is what this article is all about. Rest assured you are not alone. Main-frame manufacturers spend millions trying to overcome power line disturbances.

A look at the figures below will help you understand what can happen to incoming power. Refer to them as you read the explanations.

Figure # 1

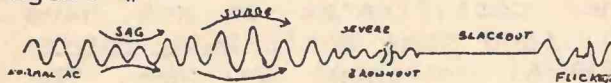

Figure # 2

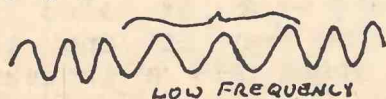
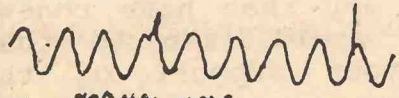

Figure # 3



Note: Do not be concerned about normal versus common mode transients. The effects they can have on your machine are the same.

Figure # 1 Voltage Variations:

Short term undervoltages (sags) are caused when large loads, such as air conditioners, are applied to the utility line.

Short term overvoltages (surges) usually occur, conversely, when such large loads are removed from the line. Typically, surges and sags last anywhere from half a second to several seconds (30 cycles to 100 or more).

Long term undervoltages (brown-outs) are deliberate cutbacks by the utility company, during peak demand, to lower overall consumption to a level that can be maintained. Expect brownouts during heat waves, peak manufacturing hours, etc..

Power interruptions (blackouts) can be due to lightning, accidents or system failure, and can last from several seconds to several hours. More common, though, are the 5 millisecond (ms) to 500 ms ( $\frac{1}{2}$  second) blackouts (flickers) caused by heat lightning, line switching and fault clearing by the utility.

Figure # 2 Frequency Variation

Frequency variations are caused by sudden, large changes in load (usually accomplished by surges/sags), and power switching between generating stations or between utility companies.

Figure # 3 High Frequency Transients (Glitches)

Transients (spikes) from nearby sources, such as relays, electric switches, typewriters, and



clock motors, are usually very rich in harmonics, have very fast (nanosecond) rise times, and are propagated by the power cord itself, which becomes its common mode transmission line. This is especially true of ungrounded, two-conductor cord on concrete floors.

Transients (spikes) from distant sources, such as drills, elevator motors, and compressors (any device with sufficient noise energy to be propagated through distribution panels and circuit breakers, even from blocks away; and then through the power cord) are usually normal mode, are longer in duration, and have slower (microsecond) rise times. Similar duration, but common mode, transients can be caused by transformer arcing and lightning.

Since home computers use regulated DC power; frequency variations (Figure # 2) will have little effect, except possibly on synchronous peripherals, such as some disk drives.

Usually your voltage regulator deals very nicely with sags and surges (Figure # 1) unless they are so frequent that overheating of the regulator results. If that is happening you should consider a larger heat sink (with adequately applied heat sink compound), or even a higher rated regulator. Opt for a new application of heat sink compound first. It does age.

If you are plagued with brown-outs or blackouts, you should definitely leave your computer off during such times or invest in a battery back-up system. DO NOT forget to check and maintain battery back-up systems regularly and religiously!

Transients (Figure # 3) are your principal enemy. They must be

dealt with where you plug your computer into incoming AC house wiring, or they will enter your computer unmolested and create a multitude of sins.

Several transients suppressors are made and sold for this purpose. If you can handle a soldering iron you can make your own. Directions follow:

**GOOD:** Simply placing a 0.1 microfarad capacitor (400VDC) across the lines will help tremendously.

**BETTER:** Make a low-bandpass filter. One suggested by the E.I.A. is shown in Figure # 4 below. DO NOT use a capacitor rated at less than 400VDC, or a capacitor not certified for use on power lines for any reason!

**BETTER YET:** Use a commercial EMI filter (such as CORCOM's) or the filter in Figure # 4; and put a MOV across the line. The MOV acts like two parallel opposed diodes which change in resistance with the incidence of a glitch. Also, include a properly rated circuit breaker to help block any really big surges. It just may save your computer.

Figure # 4 FILTER

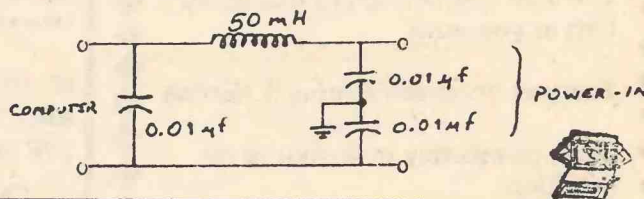

@@  
 COCOTAPE

-----  
 A Machine Language Tape to Read  
 Examine and Copy Machine Tapes  
 On Cassette: For Members - \$7.95

Send to: Steve Abrams, 1600-  
 44th Avenue, San Francisco,  
 CA 94122.

@@

**\*\* MASTERGRAPH \*\***

Draw anything on any hi-res screen using the keyboard & 1 joystick with MASTERGRAPH

Features include:

- +Save picture to tape
- +Text on the hi-res screens
- +Single key access to Ext. BASIC graphic commands
- +Auto color reverse & more!

Two versions--16K and 32K. Both versions on one tape plus three sample pictures ...only \$11.95!

Send cash, check, or money order (no CODs) to:

Mike Hall  
3019 Sylvester Drive  
Hartland, WI 53029

Send a SASE for full description.

**ROULETTE**

This well known casino game is now available for the 32K extended basic machine.

Use your joystick to place as many bets as you want:

Features on screen scoring & betting

Done completely in 4 color hi-res graphics.

**ONLY \$ 9.95**

Gerry Schechter  
75 Midland Terrace  
Yonkers, NY. 10704

Send certified check or money order only!

**PCLEAR 80 Software...**

Offers to members of the International Color Computer Club, Inc. special prices on a wide variety of software. Take 10% off any software order from PCLEAR 80.

**\*\*\* NEW! \*\*\***

ZAXXON *32K* (Data Soft)	\$39.95 TP OR DSK
ROBOTTACK (INTRACOLOR)	\$24.95 TAPE
	\$27.95 DISK
TRAP FALL (Tom Mix Software)	\$27.95 TAPE
MS. GOBBLER (Spectral Associates)	\$21.95 TAPE
	\$24.95 DISK
DEATH TRAP (Soft Sector Mkt.)	\$19.95 TAPE
COLOR CATERPILLAR (Soft Sector)	\$19.95 TAPE

**OLD FAVORITES**

THE KING *32K* (Tom Mix)	\$26.95 TAPE
(Formerly DONKEY KING)	\$29.95 DISK
COLORPEDE (Intracolor)	\$29.95 TAPE
	\$32.95 DISK
PROTECTORS *32K* (Tom Mix)	\$24.95 TAPE
	\$27.95 DISK

**BUSINESS -- UTILITIES**

TELEWRITER-64 (Cognitec)	\$49.95 CASS
	\$59.95 DISK
T. I. M. S. *E.B.* (Sugar Software)	\$24.95 CASS
WORKSAVER (Platinum Software)	\$30.00 CASS
TAPE TO DISK (Tom Mix)	\$17.95
TAPE DUPE (Tom Mix)	\$16.95
FIXER (Tom Mix)	\$17.95

ALL PROGRAMS 16K NON-EXT. UNLESS NOTED

WE HAVE A FEW OLD RAINBOWS (PRE-JULY '82) LEFT AS WELL AS MARCH '83 ON. WE ALSO HAVE THE NEW COLOR COMPUTER MAGAZINE (\$2.95 EA.)

CALL OR WRITE FOR LATEST CATALOG TODAY!



**PCLEAR 80 SOFTWARE**  
494 Cline Avenue  
Mansfield, OH 44907  
(419) 756-4873



Note: We also carry the RAINBOW



Add \$2 shipping on orders less than \$50. Please add \$2 for COD. Ohio residents add 5% state sales tax

# THE POPPING KEY FIX:

Does the PLAY key on your tape recorder pop up in the middle of a CLOAD? Well mine DID. Aggravation city! The following is an easy fix for the problem. (I expect it'll work for most any "key" operated recorder. Mine is a Radio Shack.)

You need only two tools and about a half hour, a small Phillips type screwdriver and a small pair of "diagonal" cutting pliers. Mine are about four inches long. (If you don't have'em, get'em. You can use them as toe nail cutters, or maybe you already have a pair of toe nail cutters you can use.)

Anyway get the tools, your recorder and a towel together on your table. Fold the towel double or triple thick for a cushion and put the recorder on the towel up side down, Figure # 1. Remove the battery tray cover. One of the three bottom cover retaining screws; 1A, 1B, 1C is in the bottom of the battery tray. Remove the three screws shown in Figure # 1.

Remove the recorders' bottom cover. Be careful not to pull on the attached battery wires. (Mine had enough slack so that I didn't have to worry about them.) Next take out the two screws, 2A and 2B, shown in Figure # 2. You are now ready to find out what makes the keys stay down. Look into the end of the recorder, under the HOLD/RELEASE BAR, 3F in Figure # 3. While looking press one of the KEYS. Notice that the KEY POST lifts the HOLD/RELEASE BAR and as the BAR raises the KEY POST moves back. When the POST has moved past the BAR, the BAR snaps back to it's original lower position, with the POST now behind the BAR. So the clue is to make the BAR low enough on the POST to be sure the POST can't

get back under the BAR; and there is the problem. The other KEY POSTS hold the BAR up too high. I expect the PLAY KEY POST end has just worn down. (As you might guess, I don't have a disk system.)

Anyway, take a closer look at all of the POST/BAR contact points. Note that due to the slant of the BAR the contact point is only on the back edge of the POST. It's the back edge portion of the POST that we need removed, OK?

OK, let's do it. With the recorder on the table put a small piece of something under the KEYS, 3A in Figure # 3. This allows the shell of the recorder to fall down a bit and expose the two screws, 3B & 3C. Take them out. This frees the HOLD/RELEASE BAR PIVOT PLATE, 3D. Take it out also. Now the SPRING, 3E, is loose, take it out too. Now comes a move that I didn't like, but it worked OK. That is, to get the RELEASE BAR out it must be lifted up past the FLYWHEEL. It's tail comes in contact with the FLYWHEEL and DRIVE TAPE. With a little care all goes well. (If it doesn't fit get a larger hammer.??) Once the BAR "tail" is above the FLYWHEEL a bit of jiggling of the BAR will free it too. At last we are where we want to be, at an open space above the POST ends (4A). It's those POST ends that we want to snip off on an angle, BUT NOT ALL OF THEM! Do not cut the PLAY KEY POST. That is the one that needs to be left long. Since the EJECT KEY POST doesn't hold the BAR up it does not have to be altered either.

So you are now ready to do what you came for, namely snipping off the back edge of the KEY POSTS, but not the one from the PLAY KEY. Just slip the diagonal

cutters over the POST ends on an angle similar to Figure # 4, and snip off the back edge. Take care not to reduce the length of the POSTS you cut. It's just the back edge you want to remove. (The front edge of the POST contacts the rear of the BAR to hold the KEY "down" after you have pushed it.) OK, after you have snipped off the back edge of the four KEY POSTS put all the parts back in and together, up to Figure # 3.

Now your ready to test your efforts. Push the PLAY KEY down to it's locked position. The first couple of times you may have to help the SPRING pull the BAR down as far as it will by pressing on the BAR with your finger. I had to. I guess there was a bit of hardened grease in the way. Now for the test. With the PLAY KEY in the locked down position pull up on the PLAY KEY. If it stays put you are in business; if not, take the thing apart again and snip off some more of the back edges. Be aggressive with the first snip and you won't have to do it again. Just don't remove any from the front side.

That's it, no need for hints, etc; it went as advertised for me. Hope it goes as well for you. If you have any problems or whatever, feel free to call, (609) 467-1719, Jim DeStafeno.

Note to Other newsletters and Magazines of any sort: This is a copyrighted article and can not be reproduced without notification to Mr. DeStafeno at 158 Edward Drive, Swedesboro, N.J. 08085 and without some kind of compensation to Mr. DeStafeno.

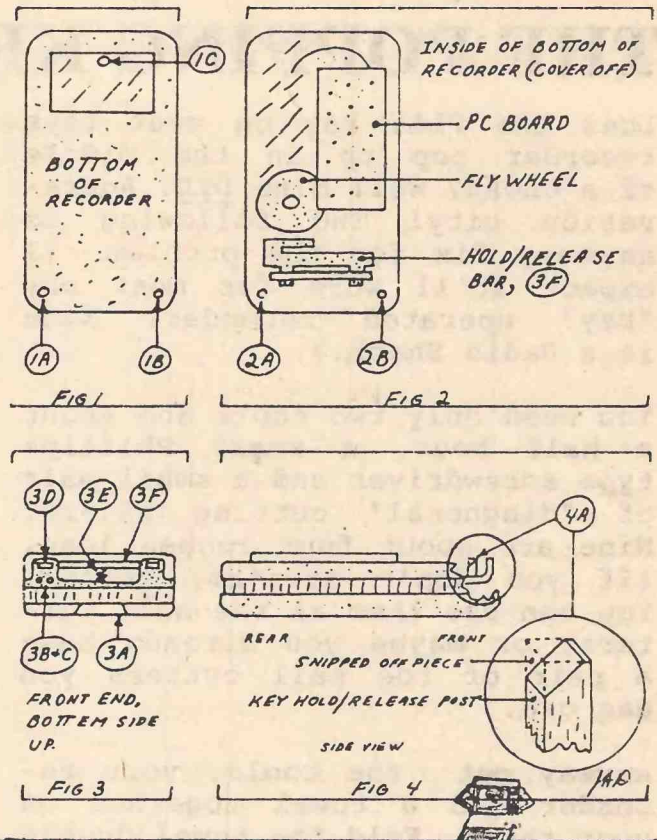

16K ZX/TS XFORNTH, despite its fullness is very compact with extra utilities (PLOT, RAND, CLS...). FORTH-79 sub-set uses simple one word call to return to BASIC, looks up Sinclair code instead of ASCII loads in one pass from cassette (no extra editor loads). 10K left for user code. \$25.00 + \$1.00 P&H

FOOTBALL FORECASTER, active data base "spread" predictor for 16K ZX/TS or 16K TRS-80C, with fully updatable factors. \$19.95 NFL or College; \$29.95 both + \$1.00 P&H.

COMPARE OUR IC PRICES: (Prices subject to change without notice)  
 -ZILOG Z80A CPU, only \$4.25 each -  
 1 x 16K DRAM, \$2.00 each - 1 x 64K DRAM, \$6.00 each. IC's first run, prime. 1-6 IC's, \$.50 P&H; 7 or more, \$1.00 P&H.

Arkansas residents add 4% tax to all items.

Pre-registered CLUBS, USER GROUPS, CAMPS 10% discount on software. MUST BE REGISTERED TO QUALIFY,  
 HAWG WILD Software, P. O. Box 7668, Little Rock, AR 72217

# REVIEW OF "RAINBOW WRITER"

by C.L.Pilipauskas (RCS)

"Congratulations! You have just purchased the ultimate in hi-res graphics text display." Normally when I read such claims I'm very skeptical, but in this case, these words quoted from the user's manual proved to be true.

Rainbow Writer (RW) is a machine language utility that overcomes some of the last complaints about the Color Computer, namely, the low density of characters on the text screen and the inability to print text on the graphics screens. Requiring 16K Extended BASIC, RW not only eliminates these shortcomings but does so with the greatest of operator ease.

The cassette I received actually contained five different programs: RW42, RW64, CGEN42, CGEN64, DEMO42.

The first two programs (RW42, RW64) gives the user his first choice of many options. Loading RW42 gives either 32 or 42 characters per line or choosing RW64 allows for 50 or 64 characters per line. After CLOAD'ing and EXEC'uting one of these programs, a menu is displayed, allowing the user to move RW to the top portion of memory for 16K, 32K, 64K RAM (the 64K option also transfers the ROM's to RAM including the cartridge, for disk users). Once the choice is made, the RW logo is printed and the underline prompt is displayed, signifying the computer is back in BASIC and ready to run with the new character density.

The next two programs (CGEN42, CGEN64), written in Extended BASIC, allows the user to redefine any or all of the

character set included with RW. The program is also menu driven, making it extremely easy to define new characters including graphics symbols on a pixel by pixel basis. The new character set can be saved to tape or disk and reloaded for later use.

The character set included with RW is quite extensive. It not only has all the upper/lower case alphanumeric but also includes the Greek math symbols, lunar landers, stick figures, card suits, etc.

The last program, DEMO42, is a demonstration program, also written in BASIC, highlighting all the features and options of RW. Examining the commented listing, the user is able to see the features of RW applied to an actual program.

Here is a list of the most important features:

- 12 character sizes (64X26 to 16X8)
- works in all PMODEs and pages
- colored characters in PMODE 1, 2, AND 4
- compatible with Radio Shack's EDTASM+
- interfaces to all BASIC commands
- error checking of all RW commands
- full ASCII 224 character set
- uses less than 5K of memory
- redefinable character set
- upper/lower case alphanumeric
- 12 new commands

The new commands allow you to scroll protect the top and/or bottom of the screen with a user-definable number of lines, print normal or double width characters, have superscript and/or subscript, underline, change color sets and colors

within each set, change density, and turn on or off the graphics screen. There is also a command to use EDTASM+. The Help command prints not only all the available commands but the present status of each, including the current PMODE.

These commands are accessible either in the direct command mode or within a program. A command is invoked by typing PRINT CHR\$(27)"command.", where the command string is one or more valid commands. The CHR\$(27)"command." string itself can be defined as a character string to save typing (e.g. A\$=CHR\$(27)"DHN.").

Though some of this may sound confusing at first, as it did to me when I first got the program, a few minutes spent with the manual and demo program will make using RW second nature.

Speaking of the manual, anybody who is going to write a manual should get a copy of RW's manual to see how it can be done right. The manual includes:

- introduction
- loading and running instructions
- operation and description of the commands
- character generator program instructions
- demo program description
- advanced topics (including tape to disk transfer, saving custom character sets, using RW with BASIC and M.L. and limited)
- PRINT @ conversion table

After using this program for about two weeks, I did manage to discover a few minor problems. The absence of an ASCII conversion table is an inconvenience when trying to use the graphics characters. You have to run one of the CGEN programs to find out the ASCII PAGE 12

equivalent for the character you want.

Probably the biggest draw back is the fact that RW slows down BASIC quite a bit. The scroll rate is listed at 120 characters a second which is substantially slower than BASIC.

In the highest density mode (64X26), the characters are printed without any space between them and it takes some time to get used to reading them, at least on my color T.V. The solution is simple, though, just use one of the other 11 densities.

The last area of concern I have, and one which I haven't had time to investigate yet, is the heavy restrictions placed on M.L. programs using RW. However, if you program only in BASIC and follow the simple rules you won't even realize it's there - until you see all the wild and new things you can achieve.

Now you can effortlessly write that ultimate word processor program with multiple character densities and sizes or that fancy arcade game with on screen scoring and text. And if your program turns out really well, you can even sell it with RW attached (see limited license in manual).

I highly recommend you try this utility; I'm sure you'll like it AND use it. (Available from RAINBOW CONNECTION SOFTWARE, 3514 6th Place NW, Rochester, MN 55901; cassette \$29.95, disk \$32.95)

Formerly distributed only by ZETA SOFTWARE, we have the original **FOOTBALL FORECASTER** with 1983 data base. Available for 16K ZX-81, T/S 1000 or 16K TRS-80 Color Computer. Specify NFL or College. Only \$19.95 each or \$29.95 for both. Add \$1.00 P&H. Ark. residents add 4% Tax.

**HAWG WILD SOFTWARE™**  
P.O. Box 7668  
Little Rock, Arkansas 72217



# LABEL PRINTER PROGRAM

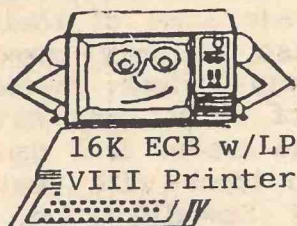

```

1 ' =====
2 ' CASSETTE LABEL PRINTER
3 ' FOR LP VIII AT 1200 BAUD
4 ' USING TRACTOR FEED LABELS
5 ' ===== WRITTEN BY =====
6 ' GERRY SCHECHTER
7 ' 75 MIDLAND TERRACE
8 ' YONKERS, NY 10704
9 ' =====
10 CLS: CLEAR200
20 DIM L$(6): POKE 150, 41
30 NO$ = CHR$(27) + CHR$(19)
40 EL$ = CHR$(27) + CHR$(14)
50 CO$ = CHR$(27) + CHR$(20)
60 PR$ = CHR$(27) + CHR$(17)
70 L6$ = CHR$(27) + CHR$(54)
80 L8$ = CHR$(27) + CHR$(56)
90 PRINT @4, "* LABEL PRINT UTILITY
  *"
100 PRINT @105, "PRINTER MODE"
110 PRINT @137, "-----"
120 PRINT @200, "1. NORMAL"
130 PRINT @232, "2. ELONGATED"
140 PRINT @264, "3. CONDENSED"
150 PRINT @296, "4. PROPORTIONAL"
160 PRINT @363, "ENTER ";
170 INPUT ""; PM
180 IF PM < 1 OR PM > 4 THEN SOUND 50, 2
   :GOTO 160
190 PRINT @417, "LINES PER INCH (6/
  8) ";
200 INPUT ""; LI
210 IF LI <> 6 AND LI <> 8 THEN SOUND 5
  0, 2:GOTO 190
220 CLS: PRINT "AT"; LI; "LINES PER I
  NCH"
230 IF PM = 1 THEN MC = 32: X$ = "NORMAL"

240 IF PM = 2 THEN MC = 16: X$ = "ELONGAT
  ED"
250 IF PM = 3 THEN MC = 48: X$ = "CONDENS
  ED"
260 IF PM = 4 THEN MC = 34: X$ = "PROPORT
  IONAL"
270 PRINT "USING "; X$; " CHARACTERS
  "
280 IF LI = 6 THEN LL = 5 ELSE LL = 6

290 PRINT "THERE ARE"; LL; "LINES PE
  R LABEL"
300 PRINT "AND A MAXIMUM OF"; MC, "C
  HARACTERS PER LINE.": PRINT
310 FOR X = 1 TO LL
320 PRINT "ENTER LINE"; X; ":"
330 LINE INPUT L$(X)
340 IF LEN(L$(X)) > MC THEN SOUND 50,
  2: PRINT "LINE TOO LONG.": GOTO 320
350 NEXT
360 CLS: PRINT "THIS IS WHAT YOU HA
  VE:": PRINT
370 FOR X = 1 TO LL
380 PRINT "LINE #"; X: PRINT L$(X)
390 NEXT: PRINT
400 INPUT "DO YOU WANT TO CHANGE A
  LINE"; YN$
410 IF LEFT$(YN$, 1) = "N" GOTO 490
420 IF LEFT$(YN$, 1) <> "Y" GOTO 400
430 INPUT "WHICH LINE "; LN
440 IF LN < 1 OR LN > LL THEN SOUND 50,
  2:GOTO 430
450 PRINT "ENTER LINE"; LN; ":"
460 LINE INPUT ""; L$(LN)
470 IF LEN(L$(LN)) > MC THEN SOUND 50
  , 2: PRINT "LINE TOO LONG.": GOTO 450
480 GOTO 360
490 CLS: PRINT
500 PRINT "LINE UP LABELS AND"
510 PRINT "HIT ANY KEY WHEN READY

520 I$ = INKEY$: IF I$ = "" GOTO 520
530 IF PM = 1 THEN PRINT # - 2, NO$;
540 IF PM = 2 THEN PRINT # - 2, EL$;
550 IF PM = 3 THEN PRINT # - 2, CO$;
560 IF PM = 4 THEN PRINT # - 2, PR$;
570 IF LI = 6 THEN PRINT # - 2, L6$;
580 IF LI = 8 THEN PRINT # - 2, L8$;
590 FOR X = 1 TO LL
600 PRINT # - 2, L$(X)
610 IF LI = 6 AND X = 3 THEN FOR Z = 1 TO 4
  : PRINT # - 2: NEXT Z
620 IF LI = 8 AND X = 4 THEN FOR Z = 1 TO 6
  : PRINT # - 2: NEXT Z
630 NEXT X
640 IF LI = 6 THEN FOR Z = 1 TO 3: PRINT # -
  2: NEXT
650 IF LI = 8 THEN FOR Z = 1 TO 5: PRINT # -
  2: NEXT
660 IF PM = 2 THEN PRINT # - 2, CHR$(27)
  ; CHR$(15);
670 CLS: PRINT "DO YOU WANT TO PRIN
  T"
  
```

```

580 INPUT"THE LABEL AGAIN ";YNS
690 IFLEFT$(YNS,1)="Y" GOT0490
700 IFLEFT$(YNS,1)<>"N" GOT0670
710 PRINT:PRINT"DO YOU WANT TO PR
INT"
720 INPUT"ANOTHER LABEL ";YNS
730 IFLEFT$(YNS,1)="Y" THEN RUN
740 IFLEFT$(YNS,1)<>"N" GOT0710
750 PRINT#-2,N0$;
760 IFPM=2 THEN PRINT#-2,CHR$(27)
;CHR$(15);
770 PRINT#-2,L6$:END

```



```

*****
I am searching for other CoCo enthusiast
who wish to trade some of their CoCo
software or wish to buy some from
me at real cheap prices. Write back
wwith a list of what you have and
what you want in trade. If I can help,
I'll get back in touch with you! Write
to me at 1000 Seagull Drive, Mount
Pleasant, S.C. 29464. Thanks for read-
ing this.

```

Mitch Cohen

\*\*\*\*\*

Part Section of Telewriter-64 Index. COST: \$2.00 For Complete Index

M. Perlmutter or P. Hester 2768 Sunnybridge Dr. Burnaby B.C. V5A-3V1

SEND FOR YOUR COPY NOW!!!

TELEWRITER-64...QUICK LOOKUP COMMANDS AND INDEX

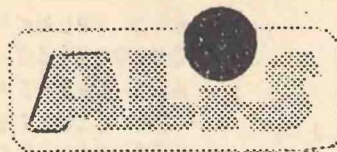

PRODUCTS OF  
AMERICAN LIBRARY AND INFORMATION SERVICES. INC

3705 MARY ELLEN NE. ALBUQUERQUE. NM 87111

Gentlemen:

- / / Yes! Send me COLOR COMPUTER INDEX 1980-1981 at \$5.00 (Canada & Mexico \$6.00)
- / / Yes! Sign me up for COLOR COMPUTER INDEX 1982 (4 Issues) for \$16.00 (Canada & Mexico \$20.00)
- / / Yes! Sign me up for COLOR COMPUTER INDEX 1983 (6 Issues) for \$24.00 (Canada & Mexico \$30.00)
- / / Yes! Sign me up for COLOR COMPUTER CATALOG 1982 (2 Issues) for \$20.00 (Canada & Mexico \$24.00)
- / / Yes! Sign me up for COLOR COMPUTER CATALOG 1983 (2 Issues) for \$20.00 (Canada & Mexico \$24.00)

Single Issues:

COLOR COMPUTER INDEX \$6.00 U.S. (except 1980-1981)  
COLOR COMPUTER CATALOG \$12.00 U.S.

NAME:= \_\_\_\_\_

Address:= \_\_\_\_\_

City:= \_\_\_\_\_ State:= \_\_\_\_\_ Zip:= \_\_\_\_\_



# LOTTO - Daily Number

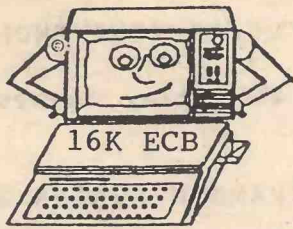

```

10 'NEXT 2 LINES; RANDOMIZING THE
RANDOM FUNCTION UPON POWERING U
P
20 X=RND(-TIMER)
30 POKE279,PEEK(275):'1 OF 4 BYTES
OF THE RND BUFFER(MEMORY LOCA- TI
ON 278T0281). TIMER(PEEK(275))
40 CLS:PRINT:PRINT:CLS3
50 PRINT
60 SOUND RND(200),RND(15)
70 PRINT
80 SOUND RND(200),RND(15)
90 PRINT"WHEN YOU SEE THE '?' & TH
E      BLINKING COLORED BLOCK,TYPE
IN  WHAT IS ASKED FOR & HIT THE
ENTER KEY"
100 SOUND200,13
110 PRINT:SOUND150,12
120 PRINT
130 INPUT"LOTTO OR DAILY NUMBER (L
/D)?";D$
140 IF D$="D"THEN GOTO 1960
150 CLS3.
160 PRINT:PRINT
170 SOUND120,11
180 PRINT"!!!==L O T T O==!!!
190 SOUND24,11
200 PRINT:PRINT
210 PRINT"- TO PLAY YOU CAN CHOOS
E EITHER A BLACK-OUT ON A TWO GAME
GRID PATTERN OR A NUMERICAL PRIN
T-OUT OF GAMES AB,ABCD,ABCDEF OR
ABCDEF GH
220 SOUND40,11
230 PRINT
240 PRINT"B ENTER FOR BLACK-OUT
250 SOUND60,11
260 PRINT
270 PRINT"P ENTER FOR PRINT-OUT
280 SOUND80,2
290 PRINT:SOUND100,12
300 INPUT"ENTER YOUR CHOICE";Q$
310 IF Q$="P"THEN GOTO1080
320 CLS:GOTO450
330 N=1085+4*N:POKE N,128
340 N=N+1:POKE N,128
350 POKE N,128

```

```

360 SOUND200,3
370 RETURN
380 M=1309+4*M
390 POKE M,128
400 M=M+1
410 POKE M,128
420 SOUND220,2
430 RETURN
440 CLS
450 PRINT:PRINT
460 PRINT" 01  02  03  04  05  06
07  08
470 PRINT" 09  10  11  12  13  14
15  16
480 PRINT" 17  18  19  20  21  22
23  24
490 PRINT" 25  26  27  28  29  30
31  32
500 PRINT" 33  34  35  36  37  38
39  40
510 PRINT:PRINT
520 PRINT" 01  02  03  04  05  06
07  08
530 PRINT" 09  10  11  12  13  14
15  16
540 PRINT" 17  18  19  20  21  22
23  24
550 PRINT" 25  26  27  28  29  30
31  32
560 PRINT" 33  34  35  36  37  38
39  40
570 A=RND(4)
580 N=A:GOSUB330
590 B=RND(40)
600 IF B=A THEN570
610 N=B:GOSUB330
620 C=RND(40)
630 IF C=A OR C=B THEN620
640 N=C:GOSUB330
650 D=RND(40)
660 IF D=A OR D=B OR D=C THEN650
670 N=D:GOSUB330
680 E=RND(40)
690 IF E=A OR E=B OR E=C OR E=D TH
EN680
700 N=E:GOSUB330
710 F=RND(40)
720 IF F=A OR F=B OR F=C OR F=D OR
F=E THEN710
730 N=F:GOSUB330
740 G=RND(40)
750 M=G:GOSUB380
760 H=RND(40)
770 IF H=G THEN760

```

```

780 M=H:GOSUB380
790 I=RND(40)
800 IF I=G OR I=H THEN790
810 M=I:GOSUB380
820 J=RND(40)
830 IF J=G OR J=H OR J=I THEN820
840 M=J:GOSUB380
850 K=RND(40)
860 IF K=G OR K=H OR K=I OR K=J THE
N850
870 M=K:GOSUB380
880 L=RND(40)
890 IF L=G OR L=H OR L=I OR L=J OR
L=K THEN880
900 M=L:GOSUB380
910 PRINT
920 INPUT"ENTER";Q
930 CLS
940 CLSO
950 PRINT:PRINT:SOUND120,5
960 PRINT"-- NOW REVIEW YOUR NUMBE
RS THAT WERE BLACKED OUT":SOUND120
,5
970 PRINT:PRINT
980 PRINTA;B;C;D;E;F
990 SOUND120,5
1000 PRINT:PRINT
1010 SOUND120,5
1020 PRINTG;H;I;J;K;L
1030 SOUND120,5
1040 PRINT:PRINT
1050 INPUT"NEW TICKET Y/N";X$
1060 IF X$="Y"THENGOTO150
1070 GOTO320
1080 PRINT"xxxxxxxxxxxxxxxxxxxxxxxxxx
xxxxxxxxxx
1090 CLS
1100 PRINT:PRINT
1110 PRINT"!!--PENNSYLVANIA LOTTO--!
!"
1120 CLS4
1130 PRINT:PRINT
1140 PRINT:PRINT"$ $ RANDOM NUMBER
GENERATOR $ $"
1150 PRINT
1160 SOUND120,12
1170 PRINT"ENTER ONE OF THE FOLLOW
ING NUMBERS FOR YOUR CHOICE"
1180 SOUND140,12
1190 PRINT"!- 2 :A-B"
1200 SOUND160,12
1210 PRINT"!- 4 :A-B-C-D"
1220 SOUND180,12
1230 PRINT"!- 6 :A-B-C-D-E-F"
1240 SOUND200,12
1250 PRINT"!- 8 :A-B-C-D-E-F-G-H"

1260 SOUND210,12
1270 PRINT
1280 INPUT"ENTER YOUR CHOICE";X
1290 CLS
1300 PRINT"$$$---play games---$$$"
1310 PRINT
1320 CLS7
1330 PRINT"RANDOM NUMBER SET A &
B"
1340 GOSUB1500
1350 GOSUB1500
1360 IF X=2 THEN GOTO1840
1370 PRINT"RANDOM NUMBER SET C &
D"
1380 GOSUB1500
1390 GOSUB1500
1400 IF X=4GOTO1840
1410 PRINT"RANDOM NUMBER SET E &
F"
1420 GOSUB1500
1430 GOSUB1500
1440 IF X=6THEN GOTO 1840
1450 PRINT"RANDOM NUMBER SET G &
H"
1460 GOSUB1500
1470 GOSUB1500
1480 GOTO1840
1490 CLS6
1500 'Q
1510 SOUND30,10
1520 A=RND(40)
1530 PRINTA;
1540 B=RND(40)
1550 IF A=B THEN GOTO 1540
1560 SOUND60,10
1570 PRINTB;
1580 C=RND(40)
1590 IF C=A THEN GOTO 1580
1600 SOUND90,10
1610 PRINTC;
1620 D=RND(40)
1630 IF D=A THEN GOTO 1620
1640 IF D=B THEN GOTO 1620
1650 IF D=C THEN GOTO 1620
1660 SOUND120,10
1670 PRINTD;
1680 E=RND(40)
1690 IF E=A THEN GOTO 1680
1700 IF E=B THEN GOTO 1680
1710 IF E=C THEN GOTO 1680
1720 IF E=D THEN GOTO 1680
1730 SOUND150,10
1740 PRINTE;
1750 F=RND(40)
1760 IF F=A THEN GOTO 1750

```

```

1770 IF F=B THEN GOTO 1750
1780 IF F=C THEN GOTO 1750
1790 IF F=D THEN GOTO 1750
1800 IF F=E THEN GOTO 1750
1810 SOUND180,10
1820 PRINT F
1830 RETURN
1840 PRINT
1850 INPUT"NEW TICKET      Y/N";Q$
1860 IF Q$="Y"THEN GOTO150
1870 FOR T=0T020
1880 CLS(RND(9)-1)
1890 SOUND RND(200),RND(3)
1900 CLS5
1910 NEXT T
1920 FOR T=0T0100
1930 PRINT"GOOD LUCK",
1940 SOUND RND(230),RND(8):GOTO1930
1950 NEXT T
1960 CLS5
1970 PRINT:PRINT
1980 PRINT"!!==---  DAILY NUMBER  ---
=!!"
1990 SOUND100,3
2000 PRINT:PRINT
2010 INPUT"ENTER";E
2020 A=RND(10)-1
2030 B=RND(10)-1
2040 C=RND(10)-1
2050 CLS4
2060 FORT=0T010:SOUND150,2:NEXT T
2070 PRINT
2080 PRINT"FIRST  DIGET=";A
2090 PRINT:FORT=0T010:SOUND160,2:NEX
TT
2100 PRINT"SECOND  DIGET=";B
2110 PRINT:FORT=0T010:SOUND170,2:NEX
T T
2120 PRINT"THIRD  DIGET=";C
2130 PRINT:PRINT:FORT=0T010:SOUND180
,2:NEXT T
2140 PRINT"##  DAILY NUMBER IS  ";A;B
;C
2150 PRINT:FORT=0T010:SOUND190,2:NEX
T
2160 PRINT:SOUND200,8
2170 INPUT"ENTER";P:GOTO10

```

(continued from page 2)  
picture of anything computer re-  
lated or of an upcoming event  
such as a holiday. You can even  
send us a story about something  
weird that happened to you when  
you were using your computer. We  
don't care what you send in to  
fill these little spaces just as  
long as we can fill them so that  
(continued on page 26)

## COCO PROGRAMS

---DATA **GRAPH** -AVG.

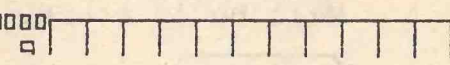
X1000 

**INCOME TAX SUMMARY:** SUMMARIZE 5 YEARS OF INCOME TAX INFO. LINE GRAPH RESULTS! (16K,ECB REQ) \$5.95 FOR PRINTER OPTION - \$8.95 (GREAT!!)

**CASSETTE LABELS:** USE PRINTER TO PRINT CASSETTE LABELS FOR MORE ORGANIZED LIBRARY. (4K/PRINTER REQ) \$5.95

**ANALYSIS:** LINE GRAPH FIGURES ON SCREEN OR PRINTER!!!! (16K,ECB/PRINTER REQ) \$12.95 FANTASTIC!!

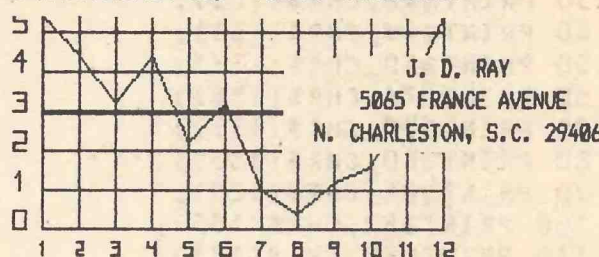

## STOCK & FUND INVESTING

FUNDGRAF is a new computer program which not only graphs and analyzes funds or stocks, but makes decisions on when to buy and sell. Use a TRS-80 Color Computer (TM Tandy Corp.) as a valuable investment tool.

- GRAPHS the progress of your funds or stocks
- SUPERIMPOSES for comparison:
  - a line of constant percent growth
  - a graph of any other fund
- CALCULATES over any given time span:
  - percent price change
  - the moving average
- INDICATES BUY and SELL signals

Tape version compares stocks or funds in groups of seven for up to 70 weeks.  
--- \$49.95

Disk version compares any 36 funds on one disk for up to 200 weeks.  
--- \$69.95

FUNDGRAF - A STOCK MARKET ANALYSIS PROGRAM FOR 16K EXT TRS-80 COLOR COMPUTER

TAPE = \$ 49.95  
DISK = \$ 69.95

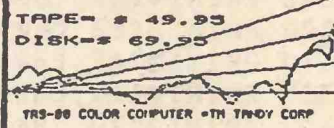

TRS-80 COLOR COMPUTER - TM TANDY CORP

-Sample data and detailed instructions furnished.  
-Both versions require 16 K Extended Basic.  
-For more information send S.A.S.E.  
-For your FUNDGRAF program send the price indicated above plus \$2.00 handling to:

**PARSONS SOFTWARE, DEPT. T**  
**118 WOODSHIRE DRIVE**  
**PARKERSBURG, WV 26101**

# TellTime

It's a simple program I wrote to teach my 6 year old how to tell time. Simply run, enter Hr:Min and return. Will be in touch, Gil

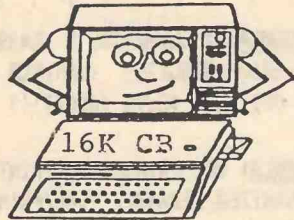

```
10•CLS
20 CLEAR 500
30 PRINT@48,CHR$(133);
40 PRINT@49,CHR$(131);
50 PRINT@50,CHR$(133);
60 PRINT@76,CHR$(138);
70 PRINT@78,CHR$(133);
80 PRINT@80,CHR$(133);
90 PRINT@81,CHR$(129);
100 PRINT@82,CHR$(135);
110 PRINT@85,CHR$(133);
120 PRINT@104,CHR$(138);
130 PRINT@105,CHR$(138);
140 PRINT@106,CHR$(130);
150 PRINT@108,CHR$(138);
160 PRINT@110,CHR$(133);
170 PRINT@112,CHR$(135);
180 PRINT@113,CHR$(131);
190 PRINT@114,CHR$(135);
200 PRINT@117,CHR$(133);
210 PRINT@120,CHR$(131);
220 PRINT@121,CHR$(133);
230 PRINT@136,CHR$(138);
240 PRINT@137,CHR$(138);
250 PRINT@138,CHR$(138);
260 PRINT@140,CHR$(139);
270 PRINT@142,CHR$(135);
280 PRINT@149,CHR$(135);
290 PRINT@152,CHR$(129);
300 PRINT@153,CHR$(135);
310 PRINT@168,CHR$(139);
320 PRINT@169,CHR$(139);
330 PRINT@170,CHR$(131);
340 PRINT@184,CHR$(131);
350 PRINT@185,CHR$(135);
360 PRINT@198,CHR$(138);
370 PRINT@199,CHR$(130);
380 PRINT@218,CHR$(131);
390 PRINT@219,CHR$(133);
400 PRINT@230,CHR$(139);
410 PRINT@231,CHR$(130);
```

PAGE 18

```
420 PRINT@250,CHR$(139);
430 PRINT@251,CHR$(133);
440 PRINT@263,CHR$(139);
450 PRINT@282,CHR$(131);
460 PRINT@283,CHR$(135);
470 PRINT@296,CHR$(138);
480 PRINT@297,CHR$(130);
490 PRINT@312,CHR$(141);
500 PRINT@313,CHR$(133);
510 PRINT@328,CHR$(138);
520 PRINT@329,CHR$(130);
530 PRINT@332,CHR$(142);
540 PRINT@333,CHR$(140);
550 PRINT@340,CHR$(140);
560 PRINT@341,CHR$(141);
570 PRINT@344,CHR$(132);
580 PRINT@345,CHR$(132);
590 PRINT@360,CHR$(139);
600 PRINT@361,CHR$(131);
610 PRINT@365,CHR$(138);
620 PRINT@368,CHR$(142);
630 PRINT@372,CHR$(132);
640 PRINT@373,CHR$(141);
650 PRINT@377,CHR$(135);
660 PRINT@397,CHR$(138);
670 PRINT@400,CHR$(138);
680 PRINT@401,CHR$(140);
690 PRINT@404,CHR$(140);
700 PRINT@405,CHR$(133);
710 PRINT@432,CHR$(138);
720 PRINT@433,CHR$(136);
730 PRINT@241,CHR$(143+64);
740 H=RND(12)
750 IF H=1 THEN 870
760 IF H=2 THEN 890
770 IF H=3 THEN 930
780 IF H=4 THEN 970
790 IF H=5 THEN 1010
800 IF H=6 THEN 1030
810 IF H=7 THEN 1060
820 IF H=8 THEN 1080
830 IF H=9 THEN 1120
840 IF H=10 THEN 1160
850 IF H=11 THEN 1200
860 IF H=12 THEN 1230
870 PRINT@210,CHR$(137);
880 H=1: GOTO 1250
890 PRINT@242,CHR$(131);
900 PRINT@211,CHR$(140);
910 PRINT@212,CHR$(131);
920 H=2: GOTO 1250
930 PRINT@242,CHR$(131);
940 PRINT@243,CHR$(131);
950 PRINT@244,CHR$(131);
```

```

960 H=3: GOTO 1250
970 PRINT@242,CHR$(140);
980 PRINT@275,CHR$(131);
990 PRINT@276,CHR$(140);
1000 H=4 :GOTO 1250
1010 PRINT@274,CHR$(134);
1020 H=5: GOTO 1250
1030 PRINT@273,CHR$(133);
1040 PRINT@305,CHR$(133);
1050 H=6: GOTO 1250
1060 PRINT@272,CHR$(137);
1070 H=7: GOTO 1250
1080 PRINT@240,CHR$(140);
1090 PRINT@271,CHR$(131);
1100 PRINT@270,CHR$(140);
1110 H=8: GOTO 1250
1120 PRINT@238,CHR$(131);
1130 PRINT@239,CHR$(131);
1140 PRINT@240,CHR$(131);
1150 H=9: GOTO 1250
1160 PRINT@240,CHR$(131);
1170 PRINT@207,CHR$(140);
1180 PRINT@206,CHR$(131);
1190 H=10: GOTO 1250
1200 PRINT@208,CHR$(134);
1210 H=11: GOTO 1250
1220 PRINT@177,CHR$(133);
1230 PRINT@209,CHR$(133);
1240 H=12: GOTO 1250
1250 M=RND(12)
1260 IF M=1 THEN 1380
1270 IF M=2 THEN 1410
1280 IF M=3 THEN 1460
1290 IF M=4 THEN 1520
1300 IF M=5 THEN 1570
1310 IF M=6 THEN 1600
1320 IF M=7 THEN 1640
1330 IF M=8 THEN 1670
1340 IF M=9 THEN 1720
1350 IF M=10 THEN 1780
1360 IF M=11 THEN 1830
1370 IF M=12 THEN 1860
1380 PRINT@179,CHR$(137);
1390 PRINT@210,CHR$(137);
1400 M=05:GOTO1900
1410 PRINT@181,CHR$(140);
1420 PRINT@212,CHR$(131);
1430 PRINT@211,CHR$(140);
1440 PRINT@242,CHR$(131);
1450 M=10:GOTO1900
1460 PRINT@242,CHR$(131);
1470 PRINT@243,CHR$(131);
1480 PRINT@244,CHR$(131);
1490 PRINT@245,CHR$(131);
1500 PRINT@246,CHR$(131);
1510 M=15:GOTO1900
1520 PRINT@242,CHR$(140);
1530 PRINT@275,CHR$(131);
1540 PRINT@276,CHR$(140);
1550 PRINT@309,CHR$(131);
1560 M=20:GOTO1900
1570 PRINT@274,CHR$(134);
1580 PRINT@307,CHR$(134);
1590 M=25:GOTO1900
1600 PRINT@273,CHR$(133);
1610 PRINT@305,CHR$(133);
1620 PRINT@337,CHR$(133);
1630 M=30:GOTO1900
1640 PRINT@272,CHR$(137);
1650 PRINT@303,CHR$(137);
1660 M=35:GOTO1900
1670 PRINT@240,CHR$(140);
1680 PRINT@271,CHR$(131);
1690 PRINT@270,CHR$(140);
1700 PRINT@301,CHR$(131);
1710 M=40:GOTO1900
1720 PRINT@236,CHR$(131);
1730 PRINT@237,CHR$(131);
1740 PRINT@238,CHR$(131);
1750 PRINT@239,CHR$(131);
1760 PRINT@240,CHR$(131);
1770 M=45:GOTO1900
1780 PRINT@173,CHR$(140);
1790 PRINT@206,CHR$(131);
1800 PRINT@207,CHR$(140);
1810 PRINT@240,CHR$(131);
1820 M=50:GOTO1900
1830 PRINT@175,CHR$(134);
1840 PRINT@208,CHR$(134);
1850 M=55:GOTO1900
1860 PRINT@145,CHR$(133);
1870 PRINT@177,CHR$(133);
1880 PRINT@209,CHR$(133);
1890 M=00:GOTO1900
1900 PRINT@448,"WHAT TIME IS IT"
1910 INPUT A,B
1920 IF A=H THEN 1930
1930 IF B=M THEN 1960
1940 CLS:PRINT@236,"H":"M
1950 END
1960 CLS:PRINT@236,"CORRECT"
1970 END
1980 'TELLTIME BY
1990 'GIL LETELLIER
2000 '56 SHELTER RK RD
2010 'BETHEL CT 06801

```



# FIRECOPTER

by Ron Woerner

In Firecopter, you are a firefighter trying to put out fires set by the minions Pyro Maniac-the mindless but persistent firedroids. To aid you in this endless quest, you have the most technologically advanced firefighting helicopter ever built. You must not only put out the fire, but destroy the firedroids before they can start more fires. There are also sniper-droids that you have to destroy before they destroy you.

Points are awarded for each 'droid destroyed and for each fire extinguished. The firedroids are worth 500 points; the sniper-droids are worth 300 points. The value of a fire is determined by its size and how long it takes you to put it out.

This is a good game by Adventure International, who has just started producing CoCo software. The joystick action is not easy getting used to, but after a while it becomes easier. The graphics and sound for this machine language game is pretty good, while the action is great trying to shoot at the enemy while trying to put out fires.

(cont. from page 5)

club and for believing that this club can (and is) doing what we promised we would do.

The people that have not renewed I would like to say "You do not know what kind of good things for your CoCo you are missing." We have obtained Three or four more discounts already and are working on one with AMDEK for their disk drives.

These members memberships have expired and they are no longer a member of our club (how awful).

PAGE 20

# TAPE I/O FIX

by Leslie Green

Would like to pass along some CoCo info to the club to start with. While attending a HAMfest (Amateur Radio affair to anyone not familiar) I talked to a fellow who was using a VIC 20 (Yuk!) and he stated that when he had problems with a tape that would not load, he simply turned the recorder upside down and 90% of the time the tape would then load. I sort of laughed up my sleeve, but when I got home I tried it. I had several programs that I had never been able to load and Lo and Behold - They ALL Loaded! I almost found it hard to believe. Just thought I'd pass this along and see if anyone else has any luck. I'm sure it has something to do with the head alignment or maybe just getting the tape in a slightly different position. I'm using the "RS" Recorder, by the way.

We send our renewal slips out two months before your membership actually expires so that you have time to work it into your budget.

So if you are up for renewal please try to renew earlier so that you don't miss any information we have for you and the other benefits.

Don

--- Don

## COLOR COMPUTER WEEKLY

Color Computer Weekly is offering a discount membership to all members of the International Color Computer Club. For the special price of \$45 you will receive a 1-year subscription to our weekly bulletin about the Color Computer (regular price is \$52). This is payable either in full or in two installments of \$23 each (it costs more to bill you).

You will receive the following: 1. A weekly issue filled with news and events, programs, reviews, special user sections including a new section aimed specifically at beginners. 2. Free hardware/software directory. 3. Dealer discounts and specials.

Send your name and address (and check) to:

COLOR COMPUTER WEEKLY  
P. O. Box 1355, Boston, MA 02205

# HARDWARE UPGRADES & INFO

## This Will Program Your Keys On *Professional Keyboard*

People who have bought the Professional Keyboard for CoCo may want to program the four function keys, F1-F4, that appear on the keyboard. One way to do this is with the following program, which will assign the following functions to the keys.

F1 - When pressed with the shift key will make a screen dump of the contents of your screen to a printer.

F2 - When held down will function as a repeat key. Any key pressed along with this key will repeat.

F3 - If you have a lowercase kit, pressing this key will "flip" between the upper case and lower case display.

F4 - A Control key. When used like a shift, it will subtract 64 from the ASCII value. For example, pressing Control and the "H" key will give you a backspace.

To make this program work, type it in and then RUN it. It will EXECute automatically. Because it POKES information into high memory, it will not interfere with your BASIC programs.

-Bob Rosen

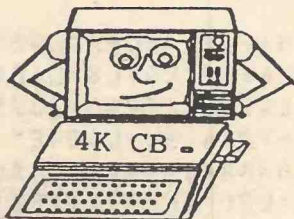

```

10 A=PEEK(116)*256+PEEK(117)
20 CLEAR200,A-227:A=PEEK(116)*256
+PEEK(117):FORX=A-227 TO A:READA$
:POKE X,VAL("&H"+A$):NEXT:EXEC A-
227:NEW
30 DATABASE,01,6B,0F,FD,9F,F8,BE,01
,68,AF,8D,00,D4,31,8D,00,15,10,BF
,01,6B,86,7E,B7,01,6A,B7,01,67,31
,8D,00,B1,10,BF,01,68,39,32,62,AD

```

```

,9F,00,F8,0F,70,0D,6F,27,03,7E,A1
,7F,BD,A1,B1,81,BD,27,F9,81,04,27
,F5,81,67,27,45,81,13,10,27,00,4E
,34,02,B6,01,56,85
40 DATA40,26,1F,86,FF,B7,01,52,B7
,01,53,B7,01,54,B7,01,55,B7,01,57
,B7,01,58,B7,01,59,86,BF,B7,01,56
,35,02,39,B6,01,58,85,40,26,D,35,
02,81,41,25,06,81,5B,24,02,80,40,
39,35,02,39,34,02,B6,01,57,85,40,
26,BA,36,02,03,FD,4F,39,34,36,B6,
01,55,85,40,26
50 DATA2F,8E,04,00,C6,20,A6,80,81
,60,26,04,86,20,20,0E,81,20,24,04
,8B,60,20,06,81,60,25,02,88,40,84
,7F,BD,A2,BF,5A,26,E0,86,0D,BD,A2
,BF,8C,06,00,26,D4,35,B6,0D,6F,26
,0A,0D,FD,27,06,81,41,25,02,88,20
,7E,CB,4A

```

### NEW PRINTER POKES FOR THE MC-100

by Bob Rosen of Spectrum Projects

Baud@	POKE
300	16932, 240
600	16932, 118
1200	16932, 60
2400	16932, 25
4800	16932, 240

FOR SALE- TRS-80 Model I Monitor and RS CTR-40B cassette machine. The monitor can be used as a B&W display with the CoCo. I will furnish the very simple info to do so. The CRT-40B can also be used with the CoCo. Both are in excellent condition. Prices..... \$60 for the monitor, \$25 for the recorder, or both for \$75. Call or write: Clay Howe, 310 S. Jefferson St., Sturgis, MI 49091 - 616-651-4248.

~~~~~

# TRS-80 MUSIC

PATRICK O'SHAUGHNESSY  
37 NESTLINGWOOD DRIVE  
LONG VALLEY, NJ 07853  
USA

\*\*\*\*\*  
SUBSTRINGS  
\*\*\*\*\*

This month's song is "Arthur's Theme" which features a study on substrings. If you will open your manual, Going Ahead With Extended Color Basic™, to page 80, you will see a section en-

80, you will see a section entitled "Executing The Substring". Read the article and notice the last part of the section under "Note:" This is very important to remember when using substrings. If you do not put a semi-colon after each substring, you will get a ?FC ERROR. You can see an example of these substrings in Line 190 of the song "Arthur"(to the right) ----->>>. Notice how there is a semi-colon after each substring? (Even the last one!)

The only problem with using this function is that once the computer starts playing the song stored in X\$(LINE 200), you cannot stop the program, or display anything on the screen until it finishes. (Unless you hit the <RESET> switch.) Next issue we will begin to put the words to these songs on the screen while it is playing, and maybe a bouncing ball.

Let's look at the listing now. Lines 10-130 are the comments and setting the speed etc. Line 140 starts storing the melody in B\$. After typing 140 in, type RUN and you should see "OK" on the screen. Now type "PLAY A\$" Presto! You are now listening to the first few lines of "Arthur".

You can do that for every line, and you could listen for bad notes. Line 190 stores in X\$ all the substrings as explained above.

Any problems? Feel free to write because I do answer each letter I get.

™ Going Ahead With Extended Color Basic is a Trademark of the Tandy Corporation.

```
10 CLEAR 200
20 REM ARTHUR'S THEME
30 REM COPYRIGHT <C> 1981
40 REM BY WB MUSIC CORPARATION
50 REM PROGRAMMED BY:
60 REM PATRICK O'SHAUGHNESSY
70 REM LONG VALLEY, NJ 07853
80 REM THIS PROGRAM MAY NOT
90 REM BE USED FOR PROFIT.
100 CLSO
110 PRINT "*****ARTHUR'S THEME*
*****"
120 PRINT "ACADEMY AWARD WINNER-
BEST SONG"
130 A$="03T4V31"
140 B$="L4F;0-L8A;0+L4DC0-B;L8GB
0+D;L4GF;L4.E;L4C;0-B;L8A;0+L4FE
DCD;0-L8FL4B-AG+;L8EG+B;0+D;0-BG
+E;0+D;0-E;0+C+E;L2E;L8E;0-L4.B;
0+L4C+E"
150 C$="0+L8FFFF;P40-;A;L4A;L8BB
;P8;L80+GDFG0-;;0+;L8EEEL4.E;L4C
FEDC;L8DDDDP4L40-;F;L2E;0+L8DP8P
4L4DL8C+E;P2P80-0-B;0+C+EA0+C+EA
"
160 D$="L8;FFFL4F0-AAL9BP4L8GBDF
;0+L8EEEL4EL8CL4FL8FL4ECO-A;0+L
8DDDDP40-L4FL8EP8P40+;DP8P4D0-BO
+C+EP20-0-P8L4.BO+L4C+E"
170 E$="L8AAAA;P8AAA;L4AG+G+L8F+
P8L4.EL8C+L2C+;L8AAC+EP8;L8C+C+C
+L4C+L8DP8P2L8BDF+B;P8L80-;AB;0+
L4C+;;G+L4AL20+E;0-L4G+A;0+L4.E
"
180 F$="0-L8AAAA;P8AAA;L4AG+G+L8
F+P8;L2EL4.EL8C+F+;P8P2P8;C+DP8D
DP8EP8F+P2P4P8;C+DP8DDP8EP8F+P4P
8C+DC+0-AAL2AP2"
190 X$="XAS;XAS;XB$;XC$;XD$;XE$;
XF$;XAS;XB$;XC$;XD$;XE$;XF$;"
200 PLAY X$
```





# BRITT MONK, CDP Special Form

**only \$14.00 post-paid**

**from Britt Monk, CDP  
P.O. Box 802  
Elyria, Ohio  
44036**



**STRIP TEASE**

**A MATHEMATICAL  
DIVERSION FOR  
MATURE GENTLEMEN!**

**RATED "R"**

**BY BRITT MONK, CDP  
P.O. BOX 802  
ELYRIA, OHIO 44036**

**\$14.00-16K-CASSETTE**

**Featuring:**

High Res Graphics \* Dancing  
Rhythms & Blues Music  
Machine Language \* Fast Action  
Sold in Plain Brown Wrapper  
Check or Money Order Only

This program is an adult math puzzle that rewards the successful player with titillating graphics and sounds, and is quite simple to play!

The pretty "Miss Byte" is hiding behind a billboard. Every time that it is the player's turn, the computer chooses one of three digits (1, 2, or 3). If the player correctly guesses which number was chosen, then a horizontal strip of the billboard will disappear, revealing a more interesting strip of "Miss Byte".

If the player chooses the wrong answer, the billboard will hide a strip of "Miss Byte", that was previously revealed.



THIS PURCHASE IS MADE THROUGH A SPECIAL ARRANGEMENT WITH THE  
INTERNATIONAL COLOR COMPUTER CLUB, INC.  
2101 EAST MAIN STREET  
HENDERSON, TEXAS 75652

BRITT MONK' CDP WILL PAY THE ABOVE CLUB A REBATE OF \$7.  
PER "STRIP TEASE" GAME FOR ALL ORDERS SUBMITTED ON THIS FORM.  
THESE MONIES ARE PAID TO THE TREASURER OF THE CLUB WHEN PAY-  
MENT FOR THE ORDER IS RECEIVED.

FROM: \_\_\_\_\_  
\_\_\_\_\_  
\_\_\_\_\_  
mem no. \_\_\_\_\_

TO: Britt Monk, CDP  
P. O. Box 802  
Elyria, Ohio 44036

PLEASE SEND THE FOLLOWING NUMBER \_\_\_\_\_ OF "STRIP TEASE" GAME(S)  
TO ME @ \$14.00 ea. FOR MY TRS-80 COLOR COMPUTER. I AM A MEMBER  
OF THE INTERNATIONAL COLOR COMPUTER CLUB, Incorporated.

# Color Graphics Editor

by Stan Saunders

When I received "Color Graphic Editor" to review, I was a little apprehensive as I have done very little Assembly Language Graphics. After reading the documentation, I was pleased to learn that the program could be used with Basic as well as Assembly Language, which greatly enhances its value.

"Color Graphic Editor" (C.G.E. from here on) is a utility written in assembly language that will enable you to design graphic figures on the screen that can be saved to disk in the form of DATA statements for DISK Basic, or in the form of FDB statements for use with a disk based Editor / Assembler. It should be noted that CGE comes on tape and can be easily transferred to disk, but does not support tape I/O. In use on a tape-based system, the DATA statements or FDB statements would have to be recorded on paper & entered from the keyboard. It should also be noted that some Assemblers do not support multiple FDB statements.

The documentation supplied with the program explains how to transfer CGE to disk, and how to utilize the DATA/FDB saves mentioned above. One feature that I liked will allow you to see a directory of your disk by answering the prompt "ENTER OUTPUT FILENAME" with a question mark (?). This will enable you to choose a filename other than one on the disk. If you should use the same filename, the original will be lost. If you do not wish to open a file, just press ENTER. If you do not specify a file, you cannot save any data to a disk file.

After designating a filename, or choosing not to open a file, you will then be asked which GRAPHICS MODE you want to use from a choice of four modes: G6R, G6C, G3C, G2C. When a mode is chosen, you will then be asked to choose one of two color sets. Color set 0 consists of Green, Yellow, Blue and Red. Color set 1 consists of Buff, Cyan, Magenta and Orange. The documentation also gives a brief discussion of the extra colors available in G6R.

You are now ready to create your graphic character. Two (2) EDIT modes are available, one that allows you to move a flashing dot cursor around a "work" box, and one that enables you to enter the HEX numeric values directly into the box to create characters. While in either of these modes, a host of commands is available. I will not cover them all, but each of them is well documented and should be easy to learn to use.

Among the commands are Disk save commands for both Basic and an Assembler. One of the most interesting features is the ability to create a character in different configurations in each of four "buffer boxes" and then with a single command, the characters can be rotated to the "work area" box for the purpose of testing animation effects. Also available is an exclusive OR function that will allow you to test different color combinations.

Using CGE with Basic programs is covered with some suggestions as to how to best use graphics in Basic. Only one screen can be saved at a time however, and the DATA statements would have to be renumbered and merged into your BASIC program.

Although the documentation states that teaching Assembler Language programming is beyond the scope of the manual, I feel that a source listing of the program would have been very informative.

I think a test mode that would show your creation in a full screen would have been useful in addition to the paging mode.

All in all, if you are looking for a utility that will assist you in designing graphic characters and save the required information to disk, this would be a very useful program and well worth the \$19.95 price. Color Graphic Editor is available from Soft Sector Marketing, Inc. 6250 Middlebelt, Garden City, MI 48135.



## Color Caterpillar

\*by MIKE HALL

You are at the bottom of a field of mushrooms, firing up at descending caterpillars, while beetles and tarantulas constantly try to destroy you. Does this sound familiar? It is the description of Color Caterpillar, an excellent version of the popular Centipede arcade game. Color Caterpillar comes on cassette, in a very colorful box with a terrifying picture of a caterpillar on it. The documentation is excellent for a program of this type, so I was off and playing only 5 minutes after I opened it.

While the program is loading, you are entertained with a low res title page. When the program is done loading, it automatically executes, and asks you if you want 1 or 2 players. Once that is chosen, you are presented with the starting screen. On it, you can move around and practice

your manuevers as much as you want, because the game doesn't start until you push the joystick button. Once you do push the button, you are off on a fast and furious caterpillar hunt!

This Centipede type game has a myriad of exciting features. First of all, it is done in 4 color high res graphics, and a lot of emphasis was put on detail. Good examples of this are the feet on the caterpillar and the tarantula. You can really see them move! The tarantula is especially neat, because it is so huge and it follows you wherever you go. It is so real looking that it actually startled me the first time I saw it!

The sound effects are another story. Sure, there is a good "pop" when you hit something, but the only other time you hear a noise is when you die or when you score 10,000 points and earn an extra man. The title page is a bit disappointing, too. It is really neat, but at the end of each game you must wait for it to "do its stuff" before you can start the next game. It probably only takes about 10 or 15 seconds, but it was quite annoying when I first started learning, because I had to start a new game every 10 or 15 seconds!

The above two points don't take much away from the game, though, because everything else about it is excellent. The joystick response is good, and the speed is unbelievable. The game has 32 levels of play that automatically progress as you play it. On about the eighth level (roughly 18,000 points), there are only 4 caterpillar heads, but they go so fast that they get to the bottom of the screen before you can even get a shot off! This game is faster than any other version I have seen.

As for the scoring, caterpillar segments are worth 80 points, tarantulas are worth 500, beetles are worth 100 (you must hit a beetle twice to destroy it), and mushrooms are worth 1 (you must hit a mushroom 4 times to destroy it). Every once in a while a mushroom will suddenly change colors. This means it has become a magic mushroom. When a caterpillar hits one, it immediately dives to the bottom of the screen. If a beetle hits a magic mushroom, that mushroom becomes a killer mushroom. When a caterpillar hits one of these, all of its body segments become heads, and they all come pouring down the screen. It is an incredible experience!!

Overall, I must say this is an excellent game for the money. I feel that a home video game should be more difficult than the original arcade game, because you get to play it a lot more. Color Caterpillar is just that kind of game. It has very fast action and is very difficult to master. I would recommend it to any Centipede fan. Watch out for that tarantula!!!

COLOR CATERPILLAR is available for \$19.95 from:  
SOFT SECTOR MARKETING, INC.  
6250 MIDDLEBELT  
GARDEN CITY, MI 48135



(continued from page 17)

you can get your newsletter on time and not two weeks late like the last newsletter was. We would also like to apologize for that too because we were waiting on the lawyer to give us the By-Laws so we could publish them. For the people that would like to have a copy of the By-Laws by themselves you can send in \$2.00 for a copy of them. Note\* It will take a couple of months since the amount of orders we get in will determine the number of copies that we print. Well that is all. Have a SAFE and Fireworky Fourth of July  
PAGE 26

## The MC-10. A Toy ??

After playing around with it for a couple of hours, I am still at a loss as to it's uses. It does have possibilities, but it has a lot of limitations also.

It's memory is up above 16K, the screen is located from 16384 to 16895, I suppose that this means you could add 16K below this and the ROM is located where we have the ROM-pack slot in CoCo. With 4K of memory that means we have 28K we could add there and have a 48K computer. That is if you can get used to the keyboard. It must have been designed for the ages 8 and under market (or for midgets) with small hands. The keyboards only redeeming factors are the control key & code words with one keystroke. It still has the sticking key problems of our CoCo. The MC-10 which I just got out of the box brand new, had 3 different keys stick while using it for the first time.

Care to go back to NON-Extended? The little MC-10 has a little bit more than a NONExtended CoCo as far as BASIC commands go. One of the most missed was EDIT. It is possible that Radio Shack plans to have expanded BASIC for it in the future and possibly more RAM but I doubt 48K.

This would be a good computer to get the kid who has been bugging you to use your CoCo. At \$119.95 you can't go wrong.

Can't you envision the MC-10 in 2 years after several companies come out with keyboards for it & Radio Shack has upgraded it to a 48K. Extended Basic with 4 disk?

Hummm, it has a SOUND command, I wonder what kind of doorbell it would make?

RON



# RAINBOWfest (exciting?)

CoCo's # 1 Show?

by Don H. Garrett

Well, I do not know if you would call it the # 1 show or not; but it was the first and it was bigger than anybody imagined it would be, so I guess you can call it # 1 until the next one. Oh yes there is a thought of having another RAINBOWfest next year (or maybe two).

Well for me (or I should say the club) it went super because we did gain 25 new members at the show. Along with the fact that I handed out around 600 applications. I did have some help from Jerry Schechter, Kathy Olson, and Kathy Goebel at times so that I could take a COKE lunch break.

These are all of the companies that had booths set up besides the club: AMDEK (new 3" disk drives), Basic Technologies (the new expansion interface for the CoCo), Bertamax, Bison Computer Services (Owner is an officer of the PC<sup>3</sup>), Bumblebee Software (That table was really humming), CERCOMP (I didn't have a chance to talk to them), Chroma Systems, Color Computer Magazine (2nd Best CoCo magazine), Color Computer Weekly (Freebies at the show), Computer House (nifty file programs), Computer Shack, DSL (the Famous Dennis Lewandoski was there), Endicott Software, Follett Library Book Company (Great Learning Games for your kids), Computer Cabinetry & Company (nifty cabinets for your Color Computer and its attachments), Frank Hogg Laboratory, Inc. (More free items over here like pins and copies or Color Computer News), Intracolor Communications (New ROBOTATTACK), J & M (A DOS package), Jarb, Micrologic, MicroNix, Moreton Bay Lab, Wayne Green Publications (They had more than Hot CoCo there), Howard Medical, Nanos Systems (still the same great little cards), Nelson Software, Petrocci Freelance Associates (Believe it or not this is a Software Company),

Prickly-Pear Software (They had (have) tapes of the fest's Seminars; but where is mine?), Radio Shack (I was hoping this would be the guys from Fort Worth but it was just a local R.S. dealer), Rainbow Connection Software (Do you need a writer? ), Star Kits, Sugar Software (SUSan and GARY), Spectral Associates (Their new Lancer program and they were giving out 30% discounts at the show), Tom Mix (Another celebrity), Transformation Technologies, and last but not least (Oh I think I will not mention this one-- Wait a minute if I do not Lonnie will shoot me so ok here goes) the RAINBOW Magazine (Falsoft, Inc.).

After all Lonnie was so willing to help me, the club, and every other exhibitor get set up and organized it would be a crime (in my book) not to say THANKS Lonnie!! for all the help, the show, and your great magazine for the Color Computer.

Those were not all the software and hardware manufacturers that were also there. Among the ones that did not have booths, that were just floating around the room, are: Britt Monk, CDP (with his new strip program), Mark Data Products, Adventure International, and Bob Rosen of Spectrum Projects.

The show went off kind of smoothly for the amount of people at the show. Everybody (the manufacturers that is) was complaining about running out of software and supplies during the last day of the show. Maybe I shouldn't say complaining because that meant that they were selling more than they had anticipated. So I guess that they were really rejoicing.

I can not give you any figures on how much was sold, bought, traded, or how many people was there. However, I can say that at times there was so many people in there trying to see all the new products on display

that at a couple of times you could hardly breath and you found yourself moving with the flow of the crowd.

After the show (and during the show) I got to talk to a few of the exhibitors and arranged a few discounts, got some samples for review (some reviews are in this issue), arranged for future meetings for demonstration, and found a distributor for our newsletter in England. I also found out what the people looked like that owned and ran those major companies. That was a real treat.

I would have pictures for you but it seems I forgot to bring my Camera; but the RAINBOW & CCW did bring their cameras and you should look in those publications for upcoming pictures of the show (and me).

It was a great thrill for me and I think all who went enjoyed it also and those who did not go: Well all I can say is that you should have.

If you need any information or would like to disagree with any information printed or about the show just contact me at: P.O. Box 1361, Henderson, TX 75653. (214) 657-7834 or at the club address.

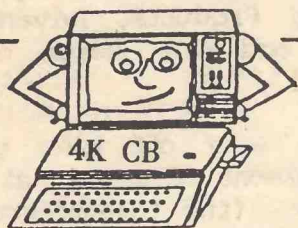

```
10 'RIFLE RECOIL BY RON GARRETT
20 CLS:INPUT"ENTER RIFLE WEIGHT"
;WR
30 INPUT"ENTER WEIGHT OF BULLET"
;WB
40 INPUT"ENTER BULLET VELOCITY";
VB
50 INPUT"ENTER WEIGHT OF POWDER
IN GRAINS";WP
60 CLS
70 E=.5*(WR/32)*(((WB*VB+4700*WP
)/(7000*WR))^2)
80 PRINT@224:PRINT"THE RIFLE PRO
DUCES ";INT(E):PRINT" FOOT POU
NDS OF RECOIL"
PAGE 28
```



## Reviews by Ron Garrett

Can you write a review? Do you really know what to say? How to say it? Well, let me give you some pointers as to what we want for the club newsletter.

First, RUN the program and find out just what it does and how it does it, and write a general description of the program, be as detailed as you can.

Second, find out if the program performs as described. Even if you feel that it is lacking in a particular section or even if it doesn't please you at all, if it performs as promised, please say that it does. If it doesn't say that it doesn't.

Third, write down your personal feelings about the program. Did you like it? Why? If you didn't like it? Why? How could it be made better? Were there any big errors? Any minor errors? Can you suggest corrections for the errors?

Fourth, give an overview of the program.

if things work out, we may send all programs out for review before we publish them or put them in the library. That way we will have a review which would serve as a form of documentation which would supplement what ever other documentation we might have.



-- Ron.

```
*****
PROGRAMS EXCHANGED The "CCOG" of
Dearborn, MICH. is looking for
public domain programs. We wish
to trade such materials with any
club or individual. The "CCOG"
Library contains fifty or so
public domain programs which we
will gladly share with others.
Please send tapes to "CCOG", c/o
Dallas Cox, 9020 Hemingway, Red-
ford, Michigan 48239. Please do
not include any copyrighted mat-
erials. THANK YOU!!!!!!
*****
```



# LETTERS TO THE CLUB

---HELP HELP HELP!---

I need help with my RS LP VII. I do alot of graphics work and therefore there is a lot of carriage returns without line feeds. That leaves ink smudges on the paper. Looks bad. How do I keep this from happening? I'm willing to go for a mechanical or electronic "fix". Anybody got any ideas?

Jim DeStafeno  
158 Edward Drive  
Swedesboro, N.J. 08085  
Res. Phone (609) 467-1719

---

Ron Garrett,

Thank you for your recent letter explaining the delay in getting my subscription to RAINBOW extended. My label for RAINBOW is now corrected.

Latest garbage gossip is print "...Radio Shack CoCo will be dropped in favor of a redesigned model that will sell for \$125.00, or so I'm told." Source 'INFOWORLD' 6 JUNE 1983 pg. 40, column 'INFO VIEWS'. Articles like this are going to discourage a large amount of potential customers from a very good experience with a COCO! I sent a letter of complaint to InfoWorld & I think we all should!

Gerald L. Brace

---

Dear Ron:

Let me begin this letter with the good news. When I opened my package which was sent as a new member kit, I was amazed and pleased. The more I examined the contents the happier I got. When I ran the new member tape my pleasure continued, and as I examined the newsletter and realized the many benefits available to a member of the I.C.C.C., Inc. I knew I had invested well in my membership.

PAGE 30

In fact, I was so surprised that I sat down and wrote a review of the entire series of events, describing in detail the benefits of the club. This review will be published in our next club newsletter which goes out to all of the members of the Capitol Area Users Group, A TRS-80 Users Group known as 'CAPATUG'.

Within CAPATUG is a recently affiliated club of approximately 35 people who are proud owners of Color Computers.

On behalf of the Color Computer Group I would like to know what has been worked out regarding affiliate club status, benefits, discounts, etc. Also, can all members of the group gain the benefits under the group affiliation or must each individual pay a membership fee, and, if so, how much?

For more good news let me report that I ordered some tapes of the available newsletters, plus several other programs which were not listed as part of the monthly tapes. These came so quickly that I could hardly believe the marvelous service. This kind of service is almost gone from business. It is certainly very much appreciated.

Unfortunately, That is the end of the good news.

When I opened the package of tapes I found that the individual programs had been entered onto a single disk. This would be fine except for the fact that I don't have disk yet. I figured that perhaps I had missed something in the ordering, and since I plan to have disk within the next few months, no real harm was done.



But when I tried to RUN the Newsletter tapes, I really became concerned about the rave review I had forwarded for publication.

Of the 6 newsletter tapes not one ran 100%. Talk about being disappointed. I really was!

Newsletter 1,3: SHORTDAT won't run

Newsletter 1,4/1,5: Nothing there

Newsletter 1,6: BUBLSORT has no INPUT facility and the remainder of the tape either won't load or is blank.

Newsletter 2,1: INVEN16 loads but won't run. Metric loads but won't convert U.S. Quarts to Liters. LORESSPT won't run.

Newsletter 2,2: IO errors, can't load anything.

From one extreme to the other. Pure joy to Pure frustration and concern.

Since I have multiple cassette units and tried these programs on two of them in case of unit malfunction, I can only assume the problem is with the tapes. I know you will be as concerned as I am, and hope that some answer can be provided.

I still have faith that my money has been well spent, but I do have concern not only about the tapes which would not load, but the apparent imperfections of some of the programs, themselves.

I am reluctant to send these tapes back to you since a few of the programs do work and are very, very good. Please advise me what to do about this problem I can, of course, copy the good programs so I won't be without them, and return the original tapes, but let me know what to do.

Sincerely yours,

Ralph C. Seward

Dear Don:

I am considering starting a payroll processing service, and am in need for a program that will do payroll. It should be user modifiable so I can use it on any check form. It must calculate payroll weekly, bi-monthly, or monthly. It must be able to do quarterly and annual reports to the IRS, following their forms, on hard copy.

The program must save and load data on tape; and use DMP-100 printer codes. It must calculate all the withholding, state, federal, FICA, etc.

It must keep a payroll journal for 12 months by employee name and number.

I have a 32K CoCo. If you or any of the members would be interested in tackling such a program, please send me an estimate and availability date.

Thank You

Jayne Kenyon  
4306 Phillip  
Billings, MT 59101



\*\*\*\*\*  
FOR SALE. Two Brand New ROMpack Cartridges!!!! Sold at very low Prices!!!!!!!!!!!! COLOR SCRIPSIT can be aquired for a greater than 35% discount (under Radio Shack's Prices)!!!!!!!!!!!! It is now only \$25.00!!!!!! Also DINO WARS is being sold at a greater than 49% discount (also under Radio Shack's prices)!!!! This is only being sold for \$15. Buy now while supplies last!!!! Send Check or Money Orders To: Stephen Rosenfeld, 88 East Greenbriar Drive, Deerfield, Ill Zip=60015 -----ORDER NOW-----  
\*\*\*\*\*

# Fill CoCo's Pot O' Gold With 81K and 45,000 A Month

"The RAINBOW isn't just the best Color Computer magazine I've ever seen. I think it's the best computer magazine I've ever been fortunate enough to read."

—J. C. Jones, New Hampshire

Letters like that are one of the reasons the RAINBOW has become the premier magazine for Color Computer users. And, in the 18 months we've been publishing the RAINBOW, we've received hundreds just like this one.

One of the reasons must be that we provide more information, programs and insight to the TRS-80® Color Computer (as well as its counterpart, the TDP System-100) than anyone else in the world.

Each month you'll receive a minimum of 81K worth of programs and 45,000 words about CoCo! They come packaged in a slick-cover, typeset first-quality package. Some 200 pages in all! The RAINBOW is the magazine CoCo users are raving about.

It's all here: Special columns on learning assembly language, interfacing CoCo to fantasy role-playing games, using CoCo as an educational tool by award-winning educator Steve Blyn, hardware modifications and two special tutorials just for beginners.

The popular Bob Albrecht offers a tutorial/column monthly on setting up data files. And the well-known Don Inman has a monthly column on his specialty—Graphics—every month. And, each month Charles Roslund's machine language utility column has a new goodie—things like a scroll protect program or a method to format listings.

Although our columns include programs you can type right in and run, that's only the beginning! The RAINBOW is literally crammed with other programs ranging from income tax help to teaching children to remember telephone numbers...combining text and graphics on the same screen to playing Christmas Carols...indexing all the programs on your disk to making printouts from bulletin boards and data bases like CompuServe.

And games! There is at least one every single issue of the RAINBOW. Games of all kinds...from shoot-'em-ups to educational. Games that require fast joystick reactions to those which make you think and plan.

Our Letters column is full of interesting hints and information. Our popular Pipeline feature provides inside news of the CoCo world. And RAINBOW reviews: More than 30 of them a month to help you decide what's good and what isn't.

The RAINBOW is the complete CoCo resource. And, best of all, its all about CoCo and nothing else. Every word, every program here is aimed at your Color Computer or TDP-100!

You can receive 12 big issues of the RAINBOW for only \$22 a year... delivered to your home or business just like clockwork every month. And, we offer a money-back guarantee. If, after seeing your first issue, you don't agree its the best \$22 you ever spent on your CoCo, just let us know. We'll happily, cheerfully and immediately refund your entire \$22.

Treat your CoCo to the RAINBOW. There's a Pot O' Gold chock full of fun and information waiting there for you!

INTERNATIONAL COLOR  
COMPUTER CLUB Inc.

2101 E. Main. St. Henderson Tx. 75652

**The RAINBOW**  
5803 Timber Ridge Drive  
P.O. Box 209  
Prospect, KY 40059



(502) 228-4492

YES! Sign me up for a year (12 issues) of the RAINBOW.

Name \_\_\_\_\_

Address \_\_\_\_\_

City \_\_\_\_\_ State \_\_\_\_\_ Zip \_\_\_\_\_

Payment Enclosed

Charge  VISA  MasterCard  American Express

My Account # \_\_\_\_\_ Interbank # (MC only) \_\_\_\_\_

Signature \_\_\_\_\_ Card Expiration Date \_\_\_\_\_

Subscriptions to the RAINBOW are \$22 a year in the United States. Canadian and Mexican rate U.S. \$29. Surface rate to other countries U.S. \$39, air rate U.S. \$57. All subscriptions begin with the current issue. Please allow up to 5-6 weeks for first copy.



# BACK ISSUES

Back Issues of the Club's Newsletters are available starting at Volume 1, # 2. All of the Volume 1 newsletters are \$1.50 Each + 50¢ postage & handling. All of the Volume 2 issues are available for the price of \$1.75 Each + \$1.00 postage & handling. Send your order to: International Color Computer Club, Inc. LIBRARY 119 County Fair, Houston, TX 77060. M.C. & VISA must be sent to the Main office for processing

Below & Side are pictures of them  
\*\*\*\*\*

PRICE: \$ 1.00  
East Texas Color Computer Club  
Newsletter Volume 1 #7



EAST TEXAS  
COLOR COMPUTER CLUB  
2101 EAST MAIN HOUSTON TEXAS 77002

The Club's Official Magazine  
is Now  
The Rainbow

In This Issue

64K. For Free  
Assembly Language  
Linking Basic to Basic  
Data File Program  
Club News

EastTex:  
Newslett



**NOTE**  
This article must have gotten ahead. Newsletter page 9 and 10 have gotten ahead. If it is actually where page 10 should be and page 10 is where page 9 should be. The page numbers are correct, just run to the correct letter. Please pay attention to this, as the program on page 9 is mentioned on page 8, and page 9 is further over the back for 40-45 lines. All items registered as in volume. However, it would have helped the volunteer workers if it had been there to be already. I thought you saw it that have the newsletter to be present? no longer of value. FROM THE SERVICE PROGRAMS THAT YOU WILL NEVER CHANGE ADDRESS

East Texas Color Computer Club  
Newsletter Volume 1 #5



NEWS PROGRAMS TRS-80C  
REVIEWS DISCOUNTS ANSWERS  
LETTERS QUESTIONS ARTICLES  
COLOR COMPUTER

WORLD'S LARGEST  
COLOR COMPUTER  
CLUB

WORLDWIDE MEMBERSHIP

Sept./Oct. 1982

East Texas Color Computer Club  
Newsletter Volume 1 #6



REVIEWS DISCOUNTS  
NEWS PROGRAMS  
LETTERS ARTICLES

WORLD'S LARGEST  
COLOR COMPUTER  
CLUB

WORLDWIDE MEMBERSHIP

Nov./Dec. 1982

International  
Color Computer Club  
Newsletter Volume 2 #1



NEWS PROGRAMS TRS-80C  
REVIEWS DISCOUNTS ANSWERS  
LETTERS QUESTIONS ARTICLES  
COLOR COMPUTER

Anniversary Edition  
WORLDWIDE MEMBERSHIP

JAN/FEB 1983

International  
Color Computer Club  
Newsletter Volume 2 #2



NEWS PROGRAMS TRS-80C  
REVIEWS DISCOUNTS ANSWERS  
LETTERS QUESTIONS ARTICLES  
COLOR COMPUTER

ROMpacks  
are back!!

WORLDWIDE MEMBERSHIP

March/April 1983

International  
Color Computer Club, Inc.  
Newsletter Volume 2 #3



NEWS PROGRAMS TRS-80C  
REVIEWS DISCOUNTS ANSWERS  
LETTERS QUESTIONS ARTICLES  
COLOR COMPUTER

NON-PROFIT CORP. FOR EDUCATIONAL PURPOSES

WORLDWIDE MEMBERSHIP

May/June 1983

# PRINTER vs. MARRIAGE

by Dan Curtin

If your wife is ready to force you to choose between her and your Radio Shack Line Printer VII or DMP-100 because its "blackboard scratching" is getting on her nerves, then take heart. There is a relatively cheap solution which might save you from divorce.

PcLEAR4co., located in Henderson Texas, has introduced a sound reducing cover for small line printers. The cover is designed specifically for the line printer VII and TRS-80 Color Computer Interface, but would work well with other brands of similar size. It is constructed of wood and covered with woodgrained colored vinyl, and has a plexiglass cover. The inside and top edges are lined with an insulating type material. The company claims that its product will cut the printer's noise in half.

I first saw this product at the RAINBOWfest computer show this last April at the Hyatt Regency Hotel in Schaumburg. I thought it was the answer to my wife's dreams and the printer noise problems. Especially astounding was the price, only \$34.95 plus \$3.00 shipping. I immediately bought the display model and took it home, anticipating to print in blissful silence from then on.

Well, not complete silence..... The PcLEAR4co. cover actually seems to cut the noise by about only a third. I personally don't feel that is too bad, since it also takes the "edge" off of the printer sound. That in itself, was worth the money. The great thing about this product, is the and the fact that it can be im-

proved to do its job better if one uses a little ingenuity. This can be done by adding more insulating material.

The only comparable products I have seen on the market, are priced at over \$100.00. The Line Printer VII cover from PcLEAR4co. does not eliminate noise, nor would you use it with your printer in the same room with a sleeping child. It does however, make your printer tolerable to your neighbors in your apartment building or to your spouse. That alone is worth the very reasonable price. It can be ordered from PcLEAR4co., P.O. Box 294, Henderson, Texas 75653-0294.

Editors Note: The PcLEAR4co. wants all Color Computer Club members to know that they get a 25% discount from them. Also, that the above mentioned cover can be custom manufactured for your own printer (minimum order of 5 covers).



**ECM** Electricity Consumption Monitor **\$10.95**

## COLOR COMPUTER 16KECB

"...a lot more than the advertisements suggest  
...very neat, compact energy monitoring routine...nice BASIC programming techniques"  
RAINBOW REVIEW April 1983

Utilize your CoCo to reduce your electric bill! Both text and graphic displays are used to display daily consumption in dollars or KWH with high, low and average days. Extra features include 20 day trend analysis and bill projection anytime during month; if you can't measure it, you can't manage it! How many programs help save your money? Sixteen page manual details operation, includes listing and forms to gather DATA. Printer NOT required.

- Money back guarantee •
- Write for free brochure on other programs •
- Include 75¢ shipping & handling •

**CoCoDATA Enterprises**

1316 Quail Avenue  
McAllen, Texas 78501

# THE GREATEST SOFTWARE DEAL ON EARTH!

**Radio Shack  
Color Computer  
TDP  
System 100**

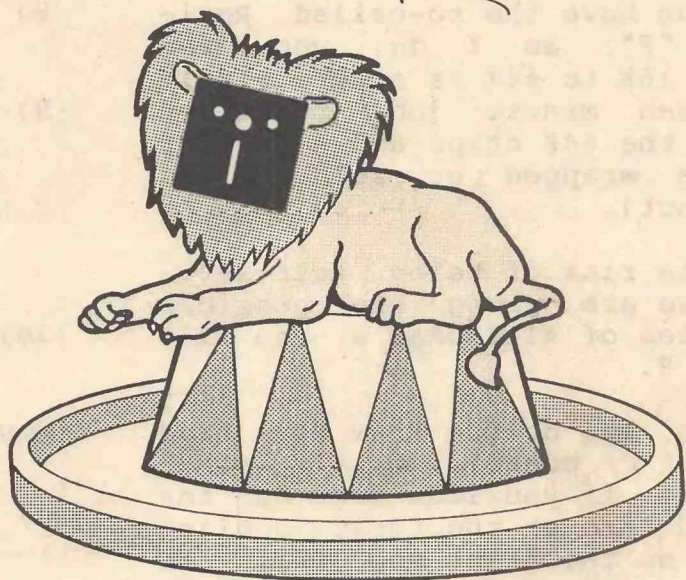
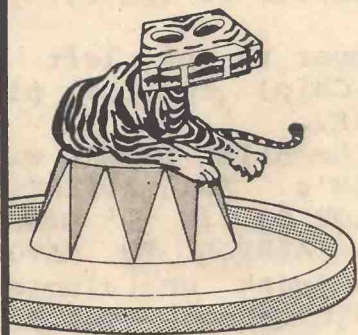

Tame your computer without breaking your wallet's spirit! Quality programs on tape or disk for the price of peanuts!

A subscription to **Chromasette Magazine** consists of 6 to 8 ready-to-load useful, practical, and fun programs delivered by First Class Mail every month. Programs like Curve Fit, Diggem, Graph Text, List Mod, Robot Run, House Adventure, and Keep Text.

Treat yourself to a great show — get a subscription to **Chromasette Magazine**. Or catch a single act and try a back issue. You'll be delighted by the tricks your computer will do!

**The Bottom Line:**

|                     | <b>Tape</b> | <b>Disk</b> | Calif. residents add 6% to single copies.                                    |
|---------------------|-------------|-------------|------------------------------------------------------------------------------|
| 1 year (12 issues)  | \$50.00     | \$95.00     | North America — First Class postage included.                                |
| 6 months (6 issues) | \$30.00     | \$55.00     | Overseas — add \$10 to subscriptions and \$1 to single copies. Sent AO rate. |
| Single Copies       | \$ 6.00     | \$11.00     |                                                                              |

**The Fine Print:**

All issues from July 1981 available — ask for list. Programs are for the Extended BASIC model and occasionally for disks.



**Chromasette** MAGAZINE

P.O. Box 1087 Santa Barbara, CA 93102 (805) 963-1066 MasterCard/Visa

# REVISION "F" 64K UPGRADE

by Gary Smith, pres. HAWG WILD  
Software

In the Nov./Dec. 1982 issue of EAST TEXAS COLOR COMPUTER CLUB NEWSLETTER Bob Rosen, president of Spectrum Projects detailed how to upgrade your Color Computer. He included all possible upgrades up through the "E" series board.

If you have the so-called Revision "F", as I do, upgrading from 16K to 64K is a very simple fifteen minute job, requiring only the 64K chips and a jumper (wire wrapped or soldered is perfect).

At the risk of being self-serving we are among the possible sources of 4164 DRAM's -you will need 8.

First, how do you know you have the "F" board? On all other boards, if you look down on the board through the first cooling slot on the right you will see the board model and Rev. numbers (An example would be:8709137-E). On Revision F (to the best of my knowledge this name was coined by Frank Hogg of Frank Hogg Laboratory) there will be nothing - literally. You can see to the bottom of the case.

On to the 15 minute procedure:

- 1) Turn the CoCo over on a cushioned surface (It is presumed you knew to remove power and all connectors)
- 2) Remove the seven screws securing the case(short ones in front-one under the warranty sticker)
- 3) Remove the five power connections to the board.

- 4) Remove the board by removing the screws securing it to the case. BE CAREFUL WITH THE KEYBOARD CONNECTOR!
- 5) Remove the RF shield - It's tabbed under on the bottom.
- 6) Remove the 8 capacitors nearest the memory chips(C58,C60,C62,C64,C66,C68,C70,C72)
- 7) Move the three (3) jumpers labled 16K/64K to the 64K position.
- 8) Add a jumper to the left of U17 (PIA Chip) to the pins labled 64K.
- 9) Replace the 8-16K DRAM's with 8-64K DRAM's. PAY ATTENTION TO THE SLOT OR PIN '1' DIMPLE BE VERY CAREFUL TO AVOID STATIC - (work on aluminum foil, avoid carpet, etc..) - THESE ARE CMOS.
- 10) Re-install the RF shield and reassemble.

How's that for quick and easy?



-Gary

---

I am in need of assistance in making changes to the ROM cartridge sold by Radio Shack "Audio Spectrum Analyzer". I need to be able to print-out the screen display of whatever display I freeze on the screen, (in black and white). I have transferred the ROMpack to disk, but I am not experienced enough in machine language to make the necessary changes.

Can you make these changes for me? How much will it cost? Will you need my ROMpack or disk? How soon can you do it? My equipment is TRS-80 ex basic, 32K, DRIVE0, VII printer.

Ted Lewis  
East Lansing, MI



International Color  
Computer Club, Inc.  
(World's Largest)  
2101 East Main St.  
Henderson, TX 75652



HERE ARE 10 GOOD REASONS  
TO JOIN THE CLUB

1. **FREE PROGRAMS.** Good programs written by our members are contained in our library, in in the newsletter, and on the new member tape.
2. **NEWSLETTER.** A "magazine" sized newsletter (which you are looking in) with programs, tips, data, reviews, articles and much more.
3. **NEWSLETTER Tape\*** A tape of all the programs in this newsletter is available from the library for \$2.00(to members) or \$4.50(to non-members).
4. **CLUB LIBRARY.** The club maintains a library of programs, books, and Radio Shack ROMpacks. The programs are member written and come six programs to a tape or disk. They are yours to keep however, there is a small fee to cover the postage and tape (or disk) of \$2.00(\$4.50 for disk). The books and ROMpacks may be checked out for 3 weeks at a time (extensions possible).
5. **DISCOUNTS.** You can get large discounts on many software and hardware items for the Color Computer from some of the MAJOR companies. Also discounts on subscriptions to the RAINBOW, Color Computer News, Color Computer Magazine, Chromasette Magazine, and CoCoCassette Magazine (up to 25% see page 1).
6. **ADVERTISE FREE.** Memers may place up to ¼ page (classified type) per issue during their entire membership in the newsletter (see page 78) FREE. Display ads at 25% off. These ads must be computer related; however.
7. **BORROW PARTS.** Don't wait weeks for the parts to come in from

- Radio Shack! Just check them out from the Club's Parts Library (located at P.O. Box 1220, Henderson, TX 75653-1220) and return them when yours arrive.
8. **SURPRISE.** You receive a "New Member" package containing many useful items.
  9. **GET HELP.** This is the world's largest Color Computer Club. With members in almost every field of expertise. So if you have a problem with the Color Computer, we can almost get you the answer. Put your problem on the Club's Bulletin Board (214) 657-8147, write, or call. Telephone No. (214) 657-7834.
  10. **FIND FRIENDS.** As a new member, you will receive a list of members in your area on a quarterly basis whom you may contact for CoCo talk.

\* The Newsletter Tape may also be purchased on disk from the library.

---

Color Computer Club

A new Club is forming in Sarasota Florida and anyone in the area is welcome to attend the meetings which are held on the last Thursday of each Month at 7:30 P.M. at Family Computers, 4047 Bee Ridge Road, Sarasota, FL. For more information call: 813-921-7510.

---

Why does high Speed POKE not work on Disk "E" Boards?

David K. Pursel  
Lainsburg, MI

---

Why does high Speed POKE take the letters "G" & "O" away from you on the "F" Board?

Curious Member

# CCMfest ?

Dear Advertisers,

I would like to take this opportunity to.....One last announcement for the Color Computer support-product manufacturers,dealers, and companies: The Color Computer Magazine, in conjunction with the Los Angeles Computer Club, is going to sponsor a consumer show for the L.A. area.

consumer show for the Color Computer on the second weekend in November in the Los Angeles area. Details are still being worked on at this point, but we know there are many Color Computer owners within easy traveling distance of L.A. The show will coincide nicely with the beginning of the biggest buying season of the year. More to come...



David Ezequelle

## SEE

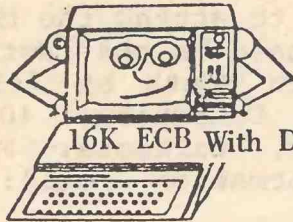

16K ECB With Disk

```

10 ' DISK UTILITY
20 ' BY PAUL A. SCHALLOWITZ
30 ' 119 COUNTY FAIR
40 ' HOUSTON, TEXAS 77060
50 ' © 1982
60 ' ANYONE WANTS TO EXCHANGE PRO
GRAMS, WRITE
70 CLS3:PRINT@200,"LOADING";
80 CLEAR 2000
90 DIM M$(90),N$(90)
100 DIM HH(90),L(90)
110 FOR X=3 TO 11
120 DSKI$ 0,17,X,A$,B$
130 C$ = A$ + LEFT$(B$,127)
140 N$(0) = LEFT$(C$,8)
150 E$(0) = MID$(C$,9,3)
160 FOR N=1 TO 7
PAGE 38

```

```

170 N$(N) = MID$(C$,N*32+1,8)
180 E$(N) = MID$(C$,9+N*32,3)
190 NEXT N
200 FOR N=0 TO 7
210 IF LEFT$(E$(N),1)>CHR$(65) AND
LEFT$(E$(N),1) <CHR$(91) AND L
EFT$(N$(N),1)<>CHR$(0) THEN 0=0+1
:M$(0)=N$(N):GOSUB 390
220 NEXT N
230 NEXT X
240 CLS:RESTORE
250 FOR L= 1 TO 0
260 READ HH(L)
270 NEXT L
280 FOR Y=1 TO 0
290 PRINT@HH(Y),M$(Y)
300 NEXT Y
310 F=FREE(0)
320 PRINT@450,"FREE ";F;" p TO
PRINT"
330 INPUT"WHICH TO LOAD";Z$
340 IF Z$="" THEN STOP
350 IF Z$="P" THEN CLS3:PRINT@192
,"PRINTING ";;GOTO 420
360 LOAD Z$
370 END
380 DATA 32,43,54,64,75,86,96,107
,118,128,139,150,160,171,182,192,
203,214,224,235,246,256,267,278,2
88,299,310,320,331,342,352,363,37
4,384,395,406,416,427,438,448,459
,470
390 IF E$(N)="DAT" THEN M$(0)=M$(
0)+". "
400 IF E$(N)="BIN" THEN M$(0)=M$(
0)+", "
410 RETURN
420 PRINT@224,"NAME OF DISK";:INP
UT A$
430 PRINT#-2,TAB(10)"---- ";A$;"
----"
440 PRINT#-2
450 A1=1:A2=2:A3=3:A4=4
460 PRINT#-2,M$(A1);TAB(10)M$(A2)
;TAB(20)M$(A3);TAB(30)M$(A4)
470 IF A3=> 0 THEN 490
480 A4=A4+4:A1=A1+4:A2=A2+4:A3=A3
+4:GOTO 460
490 CLS:PRINT@105,"ANOTHER DISK
Y/N"
500 Z$=INKEY$:IFZ$=""THEN 500
510 IF Z$="N" THEN CLS:STOP
520 IF Z$="Y" THEN CLS:PRINT#-2:P
RINT@64,"INSERT NEW DISK AND HIT
ENTER":INPUT"";Z$:GOTO 80
530 GOTO 500

```





# 80-U.S.

THE TRS-80 USERS JOURNAL

If you own a TRS-80® Model I, Model II, Model III, the Color Computer, or the new Pocket Computer, YOU NEED 80-U.S.!

## The 80-U.S. Journal has

programs for your enjoyment and enlightenment. Every issue contains several Basic or machine language program listings. It contains Business articles and program listings. No matter where you are, there is something for YOU in the Journal!

and...

The Journal contains reviews of hardware and software. Our "Evaluation Reports" will help you make the best choice in selecting additions to your system.

## Save Over 50%

You can save over 50% off the cover price of 80-U.S. Journal. For the remarkably low price of only \$16.00, a savings of \$20.00 (cover price), you will receive a wealth of useful information every month. As a special **BONUS**, if you enclose payment with your order, you will receive an extra issue for each year of your subscription order. *Order three years of 80-U.S. and receive three extra issues! At no cost to you!*

Is your  
TRS-80  
Lonely?

Write today for  
our

"No Risk Offer"

SEND TO:

80-U.S. Journal  
3838 South Warner Street  
Tacoma, Washington 98409  
Phone (206) 475-2219

Name \_\_\_\_\_

Address \_\_\_\_\_

City \_\_\_\_\_ State \_\_\_\_\_ Zip \_\_\_\_\_

Visa/MC \_\_\_\_\_

Exp. Date \_\_\_\_\_

1 yr. \$16     2 yrs. \$31     3 yrs. \$45

Please allow 6 to 8 weeks for your first issue.

TRS-80 is a Registered Trademark of the Tandy Corp.

PAGE 39



# SPECTRUM SPECIALS



- Rompak w/Blank PC Board .....\$9.95
- The Spectrum Remote Reset.....\$12.95
- The Colorcade w/Rapid Fire .....\$19.95
- Video Plus - Superb Video Interface\$24.95
- 16/32K Upgrade Kit - Lowest price..\$25.95
- Wico Red Ball Joystick.....\$34.95
- The Spectrum Joystick.....\$39.95
- Wico Analog Joystick.....\$49.95
- Super-Pro Keyboard.....\$69.95
- Botek Printer Interface.....\$69.95
- Convert Modem to Auto-Answer.....\$99.95
- Amdek Twin 3" Drive System.....\$599



**CALL 212-441-2807**

**SPECTRUM PROJECTS**

ALL ORDERS PLUS \$3.00 S/H  
N.Y. RESIDENTS ADD SALES TAX

93-15 86th DRIVE  
WOODHAVEN, N.Y. 11421



# COLOR COMPUTER DISPLAY INTERFERENCE

by J W Porter

Many CoCo owners seem to have had problems with display interference. In last month's LPRINT there was a suggestion on how to eliminate the problem with an inexpensive cable converter. Here is an alternative that may help many of you.

There are two possible causes for the interference: 1 - loss of signal; and, 2 - poor shielding. This will help with both. Many televisions of recent vintage are equipped with a 75 ohm cable input on the back (as well as a 300 ohm pair of screw terminals) which allows direct connection without a matching transformer of a converter or direct cable feed. These sets have a switch that selects either the 75 or 300 ohm inputs. Internally, there is a matching transformer between the 300 ohm input and the tuner. The cable input bypasses this and goes directly to the tuner.

The RF output on the back of the CoCo is 75 ohms, and a direct match for a cable input. If you are using the switch box that came with the computer, then there is a transformer in the switch that is converting from 75 to 300, and gives a 300 ohm output on the piece of twin lead that is to be hooked to the 300 ohm terminals. This is unshielded. Why not eliminate it?

For those with a TV with a 75 ohm coaxial connector

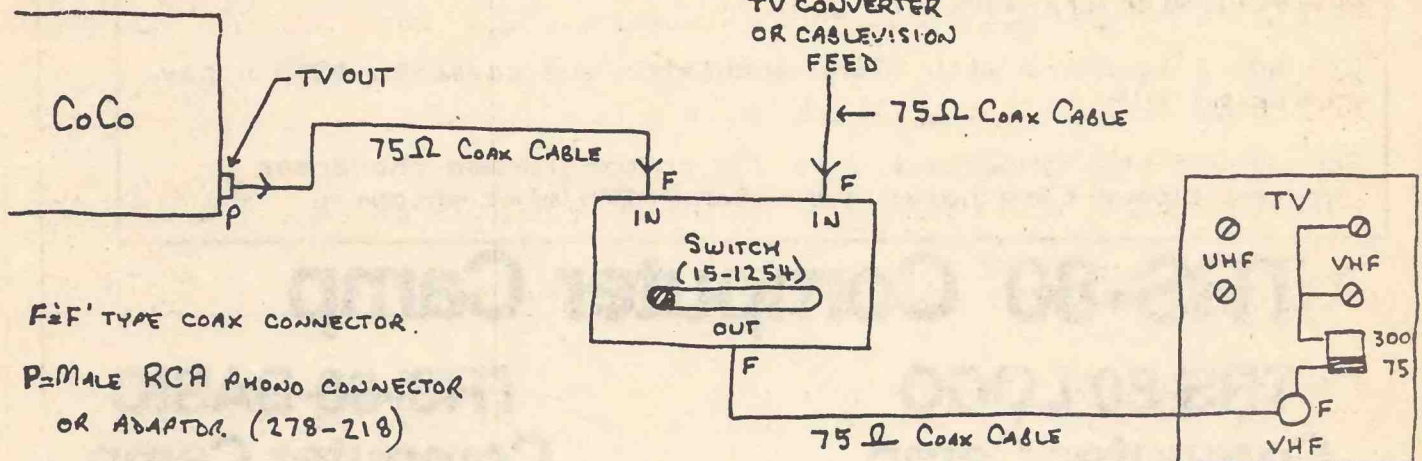

('F' type) refer to the diagram.

Prepare a length of shielded cable with a standard coaxial ('F' type) male on one end and a male RCA phone on the other. This is easily soldered on. An adaptor is available from Radio Shack (278-218) if you don't want to solder. This adaptor allows use of a standard piece of coaxial with male connectors on both ends. The other end can be connected to the 75 ohm input in the TV. Be sure to set the switch to 75 ohms on the TV. Try this direct connection. Better? You have bypassed two impedance matching transformers (some loss of signal at each likely) and a piece of unshielded twin lead.

The switch was supplied to allow you to switch inputs to the TV. You don't (at least I didn't) want to have to disconnect the computer or the cablevision to use the other. But the switch that came with the computer was also part of your problem.

Add a 75 ohm switch that maintains shielding and is easy to connect such as the Radio Shack VTR/TV/FM switch (15-1254). From the output of the switch, connect a short piece of cable to the cable input of the TV. The computer goes on one switch input, your cable (or converter) on the other.

Note: I have not tried this with a disk drive to see if it produces noise that gets through. If you have a disk, try the direct connection first before buying the new switch.

We would like to say thanks to the Micro 80 Computer Club of Ottawa's Monthly Newsletter and Brian Russell for this article!! Hi, Brian.

We are forming a Color Computer Club in the Southern part of Michigan. The name is "Michigan Color Computer Club". For more info contact: Clay Howe, 310 S. Jefferson St., Sturgis, MI 49091, (616) 651-4248. Secretary/Treasurer.

Dear Users Group,

My vocation and avocation is electronic engineering. It was only natural to buy a model 1 and my latest love the TRS-80 Color Computer.

I am in the process of developing several hardware projects for the CoCo, low cost plotter etc.

That is the purpose of this letter. I have spent many hours developing a low cost adapter to use the Atari joysticks with the CoCo.

The package includes complete documentation, schematic/parts list for building your own unit using Radio Shack parts.

Price for users groups \$9.95 ppd, the 5 pin Din plugs to connect to the rear of the unit are \$2.25 ppd.

Order by the end of June and receive instructions for interfacing the Heath Kit H-14 to the CoCo for \$2.50 additional.

Send to

Bryan McPhee  
Box 61  
New Lisbon, NJ 08064



#### Surplus Hdwe Sale

R/S PC-1 with printer \$150 ppd

R/S mod 1 keyboard with video modulator and cassette \$250 u pay shipping

Servus Systems commercial duty 132 column formed character printer (upper case only) with stand \$275 plus shipping

# TRS-80<sup>®</sup> Computer Camp

## TRS-80 LOGO Computer Camp

## TRS-80 BASIC Computer Camp

For Ages 8-11

For Ages 12-15

The Color LOGO Language

Computer Concepts for  
Young People

Enroll now at your nearby  
Radio Shack Computer Center.

# LETTERS

Ron Garret  
International Color Computer Club  
2101 E. Main St.  
Henderson,, Texas 75652

Dear Mr Garret

First of all my compliments on the March/April issue (vol.2 # 2). The number of program listings and artilces was the best yet.

If I could I would like to offer some constructive criticism of the May/June issue (vol.2 #3).

1st the artcile on custom color from Dennis Kitz, I am a big fan of Dennis from his days at 80 micro. But regard the inclusion of his article as an ad. stunt for the half baked magazine Color Computer Magazine. CCM was mass mailed free to large #'s of people to try and build up a subscription base, the article in question has also appeared in may other publications....clearly with competition from Rainbow, Color Computer News and Hot CoCo CC Magazine stands little chance of success...Nuff said.

2nd I know the problems involved in publishing a monthly computer club newsletter and often take excerpts from other club newsletters. However I never copy an entire newsletter verbatim. While it very nice to save the twenty or so members of the memphis group the cost of publishing a newsletter. I hope that this does not start a trend of completely copying any club newsletter that is received by the ICC.

3rd the reproduction of the newsletter. This month it arrived in good shape (not the usual mutilation from the postal service), however the print on several pages is so light, making it very difficult to read.

.....

On the 15th of april I sent you a check for \$8.00 (cashed 21 April) for back issues of the newsletter tapes I now understand that for \$12 per yr I can subscribe and receive the tapes. Please find an additional \$4 enclosed and start my subscription with the tape for the march/april vol2 #2 issue.

\*\*\*\*\*

Help....I have been trying to interconnect my CoCo with my mod 1 for some time now without much success.

I purchased Direct File Transfer for the mod1 and Color Computer DFT for the CoCo. I have been able to go from the mod 1 to the CoCo but not vice versa. When i get the file in the CoCo buffer and then write it out to tape it wont load as a

basic program when i try to put it back in. I thought the program CC-DLOAD from march 80 Micro Mag. would help, i keep getting the I/O error on the CoCo doesn't work at all the other way. I have also tried the program Ultra-Host on the mod 1 and i can run the mod 1 from the CoCo when i use 2 direct connect modems connected together. What I am hoping is that i have a wiring error in my interconnction of the 2 units!!!! to share my library of programs my mod1 disks and printer.

Can you suggest a mailing label program which will run on standard basic or mach lanq. which will sort by zip codes?/  
.....

I hope that the question regarding a \$5000 van to go to the post office was in jest, as in my last letter i think a quaterly newsletter program tape mailed to members would be a very good use of resources.

////////////////////////////////////

Helpfull hint use a good word processor such as Super Color Writer to type in all of your basic programs the advantages are many.

1. full editing without the necessity of buying ext basic
2. easy program merging- Color Writer doesn't care about line numbers.
3. simplified entry of repetitive statements, use the duplicate function and then change the one of two words which are different.

1001100011011

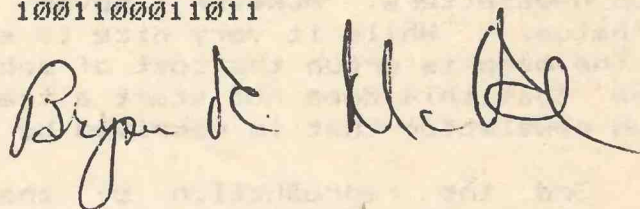

IRS80 USERS OF CHERRY HILL  
BRYAN R McPHEE PRESIDENT  
418 VIRGINIA DRIVE  
BROWNS MILLS NEW JERSEY 08015

"COPYCAMR"

BY  
JOSEPH SONGER June 1983  
1308 Merryhill Avenue  
Gadsen, Alabama 35903

COPY CAMERA

This program can be used by the shutterbug enthusiast for use with an existing copy camera or to furnish the necessary infor-

PAGE 44

mation for building a copy camera.

The camera is designed around the lens. A camera can be built as big or as small as you desire depending on the focal length of the lens. Let's say we have a 10" lens and want to make a same size (100%) copy. Double the focal length of the lens (20") and this is the distance from

(continued on Page 55)

# AFFILIATION WITH THE ICCC, Inc.

WHAT IT CAN DO FOR YOU AND HOW IT  
CAN HELP YOUR CLUB!

by Ron Garrett (pres. ICCC, Inc.)

By becoming affiliated with the ICCC, Inc. your club will have the benefits of the "World's Largest Color Computer Club" with thousands of members Worldwide, in almost any field of expertise, we can answer almost all of your questions, and solve almost all of your problems. Local clubs sometimes have difficulty in obtaining meaningful discounts from suppliers, and very little help from Radio Shack. We can offer these discounts to your members and you; plus you also have the full support of the Club's parts library which will keep your computer on line. You will have full access to our Club's Bulletin Board System and we will give you assistance in setting up a Bulletin Board of your own. We will help you purchase the hardware and software required to start a BBS, and assist you in setting it up, further, we will send you a tape of programs which appear in our newsletter for you to put on the Downloadable disk of your system.

The large library which has been assembled by the ICCC, Inc. would be sent to you in full for you to include in your library. This consists of several hundred programs and is no small consideration.

We sometimes receive very large discounts on the purchase of certain items in quantity, we realize that your club probably could not send in an order for say 500 units; however, these orders are pooled together with several other clubs so that you would get the 500 unit price even if you only order 50.

It seems like every club wants to publish a newsletter, and that is great but some clubs with say 10 to 20 members just don't have the money and time required to do so. Therefore, we will print in a special section devoted entirely to your club, any material sent to us, in the name of your club, in the ICCC, Inc. Newsletter. This may consist from 1 to 20 pages. So, for those clubs without the resources to print their own newsletter you may still have one, every two months in a special section of the ICCC, Inc. Newsletter. For those of you who do have the resources to print your own, you wish to include it in our Newsletter and still continue to print your own. This will give you worldwide exposure.

You may also place Classified type ads in our newsletter for absolutely FREE! (not over 1/4 page)

We will also assist you in setting up your By-Laws and Rules.

You will also receive all of your newsletters, new member kits, and all other correspondence at one central location (your choice) to be passed out at your meetings.

We do not have all the technical details right now; however, we feel that affiliating your club with our club will be beneficial to both of our clubs.

We would like for every local club to call for a vote on this issue and if your club votes to affiliate with our club, please write us a letter at the Main Office address.

To become an affiliate of this club, you would have to sign up every member of your club (or not less than 70%) as a member of the ICCC, Inc. along with all

future members (not less than 70%). The membership fee for this would be at a reduced rate, 2/3 of the regular price for membership. You would also have to declare your club as an affiliate of the ICCC, Inc. and put this on all of your club's letterheads, brochures, ads, and etc.

THANKS!!!



The club needs to sell some of it's older equipment in order to help pay for some newer equipment.

We will be accepting bids on the following:

1. IBM Selectric typewriter with interface for CoCo.
2. Centronics 588 printer with interface for CoCo (was bought from Leader Sales Corp.).

We will not consider a bid of less \$200.00 for the IBM or less than \$150.00 for the Centronics. Both are in good working order.

If you are interested, please send your sealed bid to: International Color Computer Club, Inc., 2101 E. Main St, Henderson, TX 75652, and write (BID) on the outside of the envelope.



Our librarian has been able to secure a good price for ICCC, Inc. Members on tapes and disks.

|                        |       |
|------------------------|-------|
| C-10 Data Cassettes    | .60   |
| C-30 Data Cassettes    | .80   |
| 5 1/4" Diskettes       | 2.55  |
| Cleaning Cassettes     | 4.95  |
| Cassette Storage Draws | 19.95 |

If you are interested in any of the above, just send your order to: Paul Schallowitz, c/o International CCC, Inc. Library, 119 County Fair, Houston, TX 77060.

from SOFTWARE SOLUTIONS  
for the Color Computer

**DISK UTILITIES. . . . . \$20.00**

A set of four essential programs for the Color Disk owner. All four sent on the same diskette for one price.

1. Alphabetize the directory--right on the disk!
2. Print the directory, PLUS entire File Allocation Table.
3. Backup directory; safeguard against accidents.
4. Print any file, including machine language programs. Each character and ASCII code printed.

**DISK FILE SYSTEM. . . . . \$20.00**

A general file system to make your Color Computer act like a "big" machine. Name variables within a file; sort in any order of variables; several options for printing records in the file; review, edit records; and more.

**CHI SQUARE STATISTIC. . . . . \$10.00**

Calculates a chi square and probability value. Prints observed and expected values. (Printer recommended, not required.)

**GAME PACK . . . . . \$10.00**

Price includes four games: Avari, Othello, Hangman, and Frantic (a recently created game). All designed for one player against the machine. Some of these are tough!

**PLAYS WITH WORDS. . . . . \$10.00**

Create your own word games with these four programs. Printer required.

1. Word Find--square of letters hides your words.
2. Scramble--mixes letters in words. Ideal for teachers, spelling checks.
3. Quotation Puzzle--Just like in the puzzle magazines, but with your words.
4. Cryptogram--solve your own, or give to friend.

**ORDER FROM:**

|                       |                        |
|-----------------------|------------------------|
| SOFTWARE SOLUTIONS    | Illinois residents add |
| P.O. Box 2431         | 5% sales tax, please.  |
| Springfield, IL 62705 | Specify Disk or Tape.  |

**NEW** for the Color Computer TRS-80

**'COCOCASSETTE' SUBSCRIPTION SOFTWARE**

\*TRS-80 IS A TRADEMARK OF TANDY COMPANY



ENJOY A MONTHLY COLLECTION OF 8-10 PROGRAMS!  
Including games, education, home finance and more; on cassette for as low as \$5.00 a month! Add some action and imagination to your Color Computer. . . Best of all, we do the work!

**PRICES**

1 YR (12 ISSUES) . . \$55.00  
6 MO (6 ISSUES) . . \$30.00  
SINGLE COPIES . . \$ 6.00

—MICHIGAN RESIDENTS ADD 4% TO ORDER  
—OVERSEAS ADD \$10.00 TO SUBSCRIPTION AND \$1.00 TO SINGLE COPIES **616 396-7577**



SUBSCRIPTION SOFTWARE

PROGRAMS ARE FOR  
EXTENDED BASIC  
MODEL ONLY. ISSUES  
ARE SENT FIRST CLASS.



SEND CHECK OR MONEY ORDER TO:



**T & D SOFTWARE P.O. BOX 256-C • HOLLAND, MICH 49423**



# NEW PRODUCT RELEASES & NEWS RELEASES

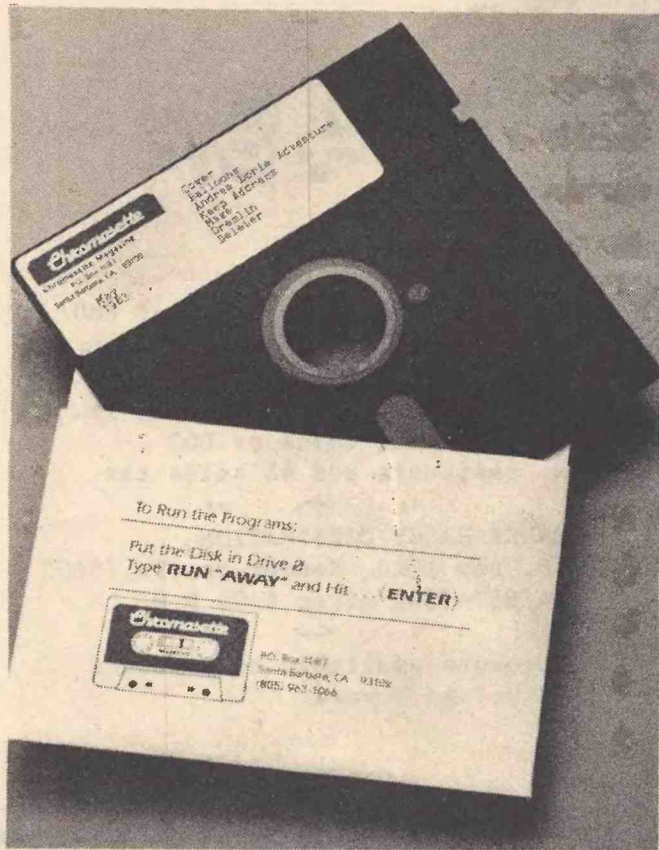

## Chromasette Magazine

They are grabbing for another almighty half-dollar by coming out with a disk Version of the already good tapes. All the issue from July 1981 will be available on the disk and cassette. The programs on the disk version may be modified somewhat to compensate for the 32K disk systems. The price is a little higher (of course, but Chromasette will still be offering the club members a \$5.00 off the subscription rate). Orders at the reduced rate are to be sent to the club. Orders without the discount rate should be sent to Chromasette Magazine, P.O. Box 1087, Santa Barbara, CA 93102.

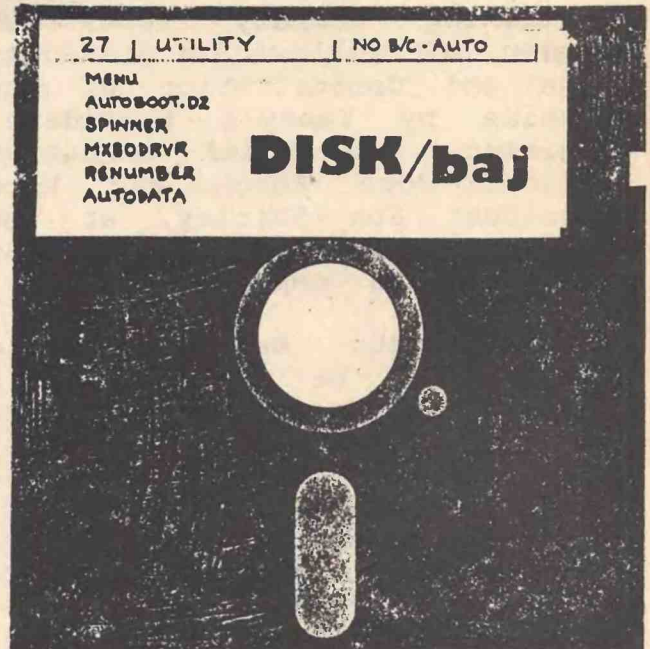

## Quintet Corp.

Look at what has finally come to be the solution to all of you disk user's problems; DISK/baj. It is a label in a sort however it is very much better than a label in the fact that you can erase the little card that slides into the slot and change it to something else without the fear of tearing up the disk. They are really cheap too (not in quality, but in price). They cost only .22¢ each in bulk of 10 up to 100. The orders must be sent to the club since they do not sell them directly. Send to: ICC, Inc. -- DISK/baj, P.O. Box 1361, Henderson, TX 75653-1361.

## Portable 100 Magazine

BOSTON, (MA) -- Tandy Corporation newest entry in the microcomputer field, the Model 100 has already spawned a new magazine designed specifically for users of the new computer.

The announcement of PORTABLE 100 Magazine was made by James S. Povec, President of Computer Publishing Company (CPC) of Camden, ME, following a presentation and demonstration of the machine by Tandy's President, Chairman, and Chief executive Officer John Roach and Vice President Jon Shirley, at the Wednesday (April 27) meeting of the Boston Computer Society.

PORTABLE 100 Magazine, said Povec will be his company's second "user specific" computer magazine. CPC's original entry in microcomputer publishing is the COLOR COMPUTER MAGAZINE, Written specifically for users of the Color Computer. For more information contact:

Kerry Leichtman  
 Computer Publishing Company  
 Highland Mill  
 Camden ME 04843

### Color Computer Pin

Guess what? PcLEAR4co. and their manufacturer has come out with a little lapel Color Computer Pin. The pin is made of pewter and is of quality workmanship. Besides the Color Computer the pin has a monitor above the Computer. Also PcLEAR4co. says that they will offer this pin to the club members at the low price of \$4.45 and that they will can custom make the little Club's Computerman for all of the club members for \$5.00 each. To order the pins in either form contact PcLEAR4co., P.O. Box 294, Henderson, TX 75653-0294.

## LETTERS



I need a copy or reprint of any article showing how to modify a TRS-80 Model I Keyboard for use in the Color Computer.

## LINE PRINTERS

\$ 149.<sup>95</sup>

CENTRONICS 588 (used) serial 600  
 Baud, 88 CPS with 4 pin DIN plug

All prices F.O.B. Henderson, Tx.  
 Terms: Cash, check or COD  
 Tx. residents add 4% sales tax

LEADER SALES CORPORATION  
 P.O. Box 1220, Henderson, Tx. 75652  
 214/657-7800 after 6:00 P.M.

Discounts available to CC clubs  
 and volume buyers.

### THE BEST IN SOFTWARE FOR KIDS!

16K CIRCUS ADVENTURE \$9.95

A child's adventure game with many songs, graphics, and surprises. Meet all of your circus favorites while searching for the popcorn man. Great family fun for all ages.



DOLLARS AND SENSE 16K \$11.95

Learn to make purchases. Graphic displays of items kids love. Player buys using dollars and coins to practice using money correctly. Solutions given.



16K SCHOOLMAZE ADVENTURE \$11.95

While in search of a lost computer tape, you travel in a school and draw pictures, compose songs, play basketball, and use the keyboard to travel in the hallways.

#### NAME THAT SONG GAMES

16K Extended \$9.95 each

1. 72 children's popular songs. 2 levels of difficulty. Timer. Many hours of fun.

2. 72 all time pop, country, and movie melodies from the last three decades.

3. 60 Broadway Show tunes to test you on past musicals. Fun for all trivia buffs.

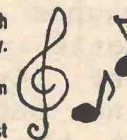

COMPUTER ISLAND  
 DEPT. E  
 227 Hampton Green  
 Staten Island, N.Y. 10312

Authors: We are seeking quality children's software for leisure or learning. Write for details. Top royalties.

# INTERNATIONAL COLOR COMPUTER CLUB, Inc. LIBRARY™



|                    |                     |                     |                     |
|--------------------|---------------------|---------------------|---------------------|
| <b>PACKAGE # 1</b> | <b>PACKAGE # 2</b>  | <b>PACKAGE # 3</b>  | <b>PACKAGE # 4</b>  |
| WUMPUS (A)         | MCJUMP (G,K)        | ADDRESS (F,C,P)     | EST CHAR (B,D,P)    |
| BLOCK (G)          | SORCERER (A)        | SUNDANCE (G,K)      | SURVIVE (A)         |
| CAR OWN (B)        | MINDER (F,C)        | CARDFILE (F,B,P)    | PILLBOX (G,K)       |
| MAILIST (B,C,P)    | SLOTS (G,K)         | KINGTUT (A)         | RELOCATE (U)        |
| TREKADV (A)        | ACCOUNT (B,C,P)     | BRICKS (G,J)        | 40 CALEN (B,P)      |
| ROTATE (G,K)       | ILLUSION (G)        | CLOCK (G)           | TEMP (U,K)          |
| <b>PACKAGE # 5</b> | <b>PACKAGE # 6</b>  | <b>PACKAGE # 7</b>  | <b>PACKAGE # 8</b>  |
| BOMBER (G,K)       | ICBM (G,J)          | YAHTZEE (G,K)       | ROLL IT (G,K)       |
| SIMEQ (B,K)        | NEWTON (B,K)        | MAILING (F,B,D)     | PARTS (B,D,P)       |
| DOC (G)            | CASTLE (A)          | PTEST (U)           | MATH (E)            |
| 32COL BP (B,P)     | INVEST (B,P)        | STARTREK (A)        | ANIMAL (G,K)        |
| INVEST 2 (B,P)     | MATH (E)            | MAZE (G,K)          | BCARAT (G,K)        |
| KEYBOARD (G)       | TEMPCOMP (U,P)      | LETWRITR (B,D,P)    | LP7WRITE (B,P)      |
| <b>PACKAGE # 9</b> | <b>PACKAGE # 10</b> | <b>PACKAGE # 11</b> | <b>PACKAGE # 12</b> |
| BLOCK (G,J)        | HORSE (G,K)         | RACE (G,K)          | UFO (G,K)           |
| DONATION (B,D,P)   | ADRLABLS (B,D,P)    | DEFEND (G,J)        | CHECKERS (G,J)      |
| SIMPSON (U,B)      | STOCKAN (B)         | ACC REC1 (B,D,P)    | PERFINAN (B,C)      |
| BOOKS (F,D)        | LETEDIT (B,P)       | MEMO (B,P)          | ORDER (B,P)         |
| JOY-FOUR (G,J)     | RECORDS (F,C)       | DISKMAP (U,D)       | PSUPPLY (U,B)       |
| METRIC 2 (B)       | BASXREF (U)         | PEGWARS (G,J)       | 40 CALEN (B,P)      |

A=Adventure F=File G=Game B=Business D=Disk E=Educational  
C=Cassette U=Utility P=Printer K=Keyboard J=Joysticks

THE FEE PER PACKAGE IS \$2.00 on TAPE AND \$4.50 on DISK.

Fee of \$2.00 is required to check out a ROMpack. Pick out two back-up choices. If you only want one, then just say so and you will

be put on a waiting list. Below is a list of ROMpacks in the Library

- |                   |                   |                      |               |
|-------------------|-------------------|----------------------|---------------|
| 1. Project Nebula | 6. Diagnostics    | 11. Shooting Gallery | 16. Dino Wars |
| 2. Skiing         | 7. Bustout        | 12. Castle Guard     | 17. Tennis    |
| 3. Typing Tutor   | 8. Chess          | 13. Videotex         | 18. Mega Bug  |
| 4. Polaris        | 9. Color Scrip.   | 14. Space Assault    | 19. Music     |
| 5. Pin Ball       | 10. Quasar Cmmnd. | 15. Football         |               |

|                                                                |       |
|----------------------------------------------------------------|-------|
| C-10 Data Cassettes for Computer data-Fully Guaranteed         | .60   |
| C-30 Data Cassettes for Computer data-Fully Guaranteed         | .80   |
| C-60 Data Cassettes for Computer data-Fully Guaranteed         | 1.00  |
| 5¼" Diskettes - Single Side Double Density                     | 2.55  |
| Cleaning Cassettes- Clean Head & Capstain with bottle of fluid | 4.95  |
| RS-232 Switch Box - Ideal between Printer and Modem            | 29.95 |
| Cassette Storage Draws - 3 Draws will hold 36 Cassette Tapes   | 19.95 |
| Flip-Top Cassette Boxes-Protect tape from dust (4 in a pack)   | 2.00  |
| Cleaner & Demagnetizer for Cassette Tapes-Clean and degauss    | 3.00  |
| Tape Head Cleaning Tape                                        | 1.50  |
| ZAXXON - Arcade Game - Great Graphics (3-D)                    | 29.95 |

Shipping Charges for the above: \$0-\$10=\$1.50, \$11-20=\$2.50, \$21-30=\$3.50, and \$31 & up = \$5.00

**NEWSLETTER 1-3**

PIVADERS (G,J)  
 SCRPRINT (U,P)  
 SHORDDAT (F,C)  
 BLOCK (G,J)  
 BUBLSORT (U)

**NEWSLETTER 1-4**

FREEWAY (G,J)  
 RANSTAR (G)  
 DRAWING (G,K)  
 MEMBERS (B,F,P)  
 LEDGER (B,F,P)  
 BUSIN (B,F,P)  
 CORTOCOR (G,J)

**NEWSLETTER 1-4**

SKETCH (G,K)  
 AREAVOL (B)  
 TUNBOX (G)  
 DISKPEEK (U,D)  
 DIRPROM (U,D)  
 SLOT (G,K)

**NEWSLETTER 1-6**

PH#LIST (F,C)  
 PERCALEN (B)  
 SCTHMKER (G)

**NEWSLETTER 2-1**

INVEN16K (B,D,P)  
 METRIC (U,B)  
 CGPDEMO (U,P)  
 LORESSPT (U,P)  
 WORDS (G,K)  
 TITLER (B,K)  
 BACH (E,M)

**NEWSLETTER 2-2**

40COLLET (B,P)  
 SALES1.9 (B,D,P)  
 5 FILE (F,D,P)  
 WIDTH (U,P)  
 CONVERT (B,K)  
 RANDGRAF (G)  
 MAZE2 (G,J)  
 CHKWRITR (B,P)  
 HI DOT (U)  
 GAMES (G)  
 FINDWORK (G,P)

**MORE 2-2**

MONTHDUE (F,D,P)  
 VIDTEX (U,P)  
 CAGE (G,J)  
 PRICE Q (B,F,D)  
 REFLEX (G,K)  
 GR DS1&2 (G)  
 TAPEINV1 (F,C,P)  
 MASH (E,M)  
 SQUARGRA (E)  
 FIGURES (G,E)  
 FORESTRY (B,P)

**NEWSLETTER 2-3**

TAPEINL1 (F,C,P)  
 BASXREF (U,C)  
 CMERGE (U,C)  
 CKBANKST (B,P)  
 TICOTICO (E,M)  
 FOURIER (U,C)  
 CAT (U,D,P)  
 COLRTRAP (G,K)  
 CLOCK (E,K)  
 ATACMAN (G,J)

THE FEE OF \$2.00 ON TAPE OR \$4.50 ON DISK.

A=ADVENTURE F=FILE B=BUSINESS G=GAMES U=UTILITY E=EDUCATIONAL D=DISK  
 C=CASSETTE P=PRINTER K=KEYBOARD J=JOYSTICK M=MUSIC

© 1983 ICC, Inc. Library™ 119 County Fair Houston Texas 77060

™ ICC, Inc. Library is a Trademark of the International Color Computer Club, Inc.



# ITEMS TO BE VOTED ON

1. The Board has voted to purchase an air conditioner for the office (A 16' by 16' space) 15000 BTU or larger. Do you vote [A] For or [B] Against this proposal?
2. The club has voted to allow local clubs to affiliate with us (we are still awaiting the paperwork from lawyers) to aid in this, the Board has voted to help set up Bulletin Boards for the ICCC, Inc. with these local clubs. With the club supplying some of the programming and equipment. Do you vote [A] For or [B] Against this proposal?
3. In addition to the above, the Board has voted to send a copy of the newsletter tape to each BBS to be put on the Downloadable Disk. Do you vote [A] For or [B] Against this?
4. The Board has voted to form a committee to outline the future direction and plans for the club's future expansion. This is to be composed of 12 members (Not necessarily local). This committee is to be appointed and confirmed by the general vote. The committee shall submit their proposals to the Board no later than Nov. 1st, 1983. Do you vote [A] For or [B] Against this proposal?
5. If proposal # 4 is ratified, would you consider serving on this committee? Vote [A] for YES or [B] for NO. If you vote Yes, then please include your complete name address and phone # on the remarks lines.
6. Excluding the newsletter printing fees, the Board has voted to allow office purchase

and payouts of up to \$500.00 without a call for a General Vote, anything which would cost more than \$500.00 must be approved by the Board and Ratified by the members. Do you vote [A] For or [B] Against this proposal?

7. The Board has voted to obtain insurance to cover the office equipment which belongs to the club. Do you vote [A] For or [B] Against this proposal?

Don't forget that if you have an idea that you think is worth voting on then please send it in to the attention: Newsletter Editor, Voting, International Color Computer Club, Inc. or write it on the Comments section of your vote card.



## VOTING RESULTS OF LAST ISSUE

|          |           |          |
|----------|-----------|----------|
| Item # 1 | 99.3% Yes | 00.7% No |
| Item # 2 | 97.0% Yes | 03.0% No |
| Item # 3 | 97.0% Yes | 03.0% No |
| Item # 4 | 60.0% Yes | 40.0% No |
| Item # 5 | 90.4% Yes | 09.6% No |
| Item # 6 | 52.6% Yes | 47.4% No |

|          |                  |         |
|----------|------------------|---------|
| Item # 7 | -- Ron Garrett   | had 27% |
|          | Don H. Garrett   | had 20% |
|          | Kathy Goebel     | had 22% |
|          | Paul Schallowitz | had 21% |
|          | Larry Laird      | had 4%  |
|          | Mike McCullough  | had 4%  |
|          | Rick Poland      | had 2%  |

Mike McCullough and Rick Poland withdrew from the race however & they would not be a Director even if they had gotten enough votes.

All votes are public domain and are open to the members for viewing if they come by the office.



ZAXXON (ARCADE GAME)

ZAXXON AND THE DEADLY HOMING MISSILE SCORES A DIRECT HIT WITH ARCADE GAME ENTHUSIASTS. ONE OF THE MOST SUCCESSFUL ARCADE GAMES OF 1982 BY SEGA IS NOW AVAILABLE FOR HOME USE ON YOUR RADIO SHACK CC, BY DATASOFT. ZAXXON COMBINES TOTALLY UNIQUE COLOR GRAPHICS WITH UNPRECEDENTED 3-DIMENSIONAL EFFECTS. YOU'LL MANEUVER YOUR SHIP THROUGH A BATTLEFIELD OF STATE-OF-THE-ART ENEMY MISSELES, ANTI-AIRCRAFT TANKS, A FLEET OF ENEMY PLANES AND REALISTIC SOUND EFFECTS. SURVIVE ALL THAT AND YOU'LL MEET YOUR MATCH IN THE DEADLY ZAXXON ROBOT, ARMED WITH A LETHAL HOMING DEVICE. JUST WHEN YOU THOUGHT IT WAS SAFE TO GO HOME..... CASSETTE \$29.95 DISK \$29.95 PLUS \$1.50 SHIPPING

PAUL A. SCHALLOWITZ 119 COUNTY FAIR HOUSTON, TEXAS 77060  
PAGE 52

# Off the Shelf

MEMORY LOCATIONS 65280 (HEX FF00) TO 65284 (HEX FFO3) ARE THE PIA WHICH CONTROLS THE KEYBOARD INPUT (AMONG OTHER THINGS)

HERE IS WHAT THEY DO.

65280 BIT 0=KEYBOARD ROW 1 and right joystick switch  
BIT 1=KEYBOARD ROW 2 and left joystick switch  
BIT 2=KEYBOARD ROW 3  
BIT 3=KEYBOARD ROW 4  
BIT 4=KEYBOARD ROW 5  
BIT 5=KEYBOARD ROW 6  
BIT 6=KEYBOARD ROW 7  
BIT 7=JOYSTICK COMPARISON INPUT

65281 BIT 0=CONTROL OF THE HORIZONTAL  
0=IRQ TO CPU DISABLED  
1=IRQ TO CPU ENABLED  
BIT 1=SYNC CLOCK  
(63.5 microseconds)  
0=FLAG SET ON FALLING EDGE OF HS  
1=FLAG SET ON RISING EDGE OF HS  
BIT 2=(NORMALLY 1)  
0=CHANGES 65280 TO THE DATA DIRECTION REGISTER  
BIT 3=SEL 1: LSB OF THE TWO ANALOG MUX SELECT LINES  
BIT 4=1 ALWAYS  
BIT 5=1 ALWAYS  
BIT 6=NOT USED  
BIT 7=HORIZONTAL SYNC INTERRUPT FLAG

65282 BIT 0=KEYBOARD COLUMN 1  
BIT 1=KEYBOARD COLUMN 2  
BIT 2=KEYBOARD COLUMN 3  
BIT 3=KEYBOARD COLUMN 4  
BIT 4=KEYBOARD COLUMN 5  
BIT 5=KEYBOARD COLUMN 6  
BIT 6=KEYBOARD COLUMN 7  
BIT 7=KEYBOARD COLUMN 8

65283 BIT 0=CONTROL OF THE FIELD SYNC CLOCK  
0=IRQ TO CPU DISABLED

1=IRQ TO CPU ENABLED  
BIT 1=16.667 Ms Interrupt input  
0=SETS FLAG ON FALLING EDGE OF FS  
1=SETS FLAG ON RISING EDGE OF FS  
BIT 2=(NORMALLY 1)  
0=CHANGES 65282 TO THE DATA DIRECTION REGISTER  
BIT 3=SEL 2: MSB OF THE TWO ANALOG MUX SELECT LINES  
BIT 4=1 ALWAYS  
BIT 5=1 ALWAYS  
BIT 6=NOT USED  
BIT 7=FIELD SYNC INTERRUPT FLAG

PIA FOR RS-232, CASSETTE, SOUND AND VIDEO DISPLAY GENERATOR IS LOCATED AT MEMORY LOCATIONS 65312 TO 65315 (FF20 TO FF23) HERE IS HOW IT BREAKS DOWN.

65312 BIT 0=CASSETTE DATA INPUT  
BIT 1=RS-232 DATA OUTPUT  
BIT 2=6 BIT D/A LSB  
BIT 3=6 BIT D/A  
BIT 4=6 BIT D/A  
BIT 5=6 BIT D/A  
BIT 6=6 BIT D/A  
BIT 7=6 BIT D/A MSB

65313 BIT 0=CONTROL OF THE CD  
0=FIHQ TO CPU DISABLED  
1=FIHQ TO CPU ENABLED  
BIT 1=RS-232 STATUS INPUT  
0=SET FLAG ON FALLING EDGE OF CD  
1=SET FLAG ON RISING EDGE OF CD  
BIT 2=(NORMALLY 1)  
0=CHANGES 65312 TO THE DATA DIRECTION REGISTER  
BIT 3=CASSETTE MOTOR CONTROL 0=OFF 1=ON  
BIT 4=1 ALWAYS  
BIT 5=1 ALWAYS  
BIT 6=NOT USED  
BIT 7=CD INTERRUPT FLAG

65314 BIT 0=RS-232 DATA INPUT  
 BIT 1=SINGLE BIT SOUND  
 OUTPUT  
 BIT 2=RAM SIZE  
 BIT 3=VDG CONTROL OUTPUT  
 CSS  
 BIT 4=VDG CONTROL OUTPUT  
 GM0 & INT/EXT  
 BIT 5=VDG CONTROL OUTPUT  
 GM1  
 BIT 6=VDG CONTROL OUTPUT  
 GM2  
 BIT 7=VDG CONTROL OUTPUT  
 A/G

65315 BIT 0=CONTROL OF THE  
 CARTRIDGE  
 0=FIRO TO CPU DISABLE  
 1=FIRO TO CPU ENABLED  
 BIT 1=INTERRUPT INPUT  
 0=SETS FLAG ON  
 FALLING EDGE OF CART  
 1=SETS FLAG ON RISING  
 EDGE OF CART  
 BIT 2=(NORMALLY 1)  
 0=CHANGES 65314 TO  
 THE DATA DIRECTION  
 REGISTER  
 BIT 3=SIX BIT SOUND ENABLE  
 BIT 4=1 ALWAYS  
 BIT 5=1 ALWAYS  
 BIT 6=NOT USED  
 BIT 7=CARTIDGE INTERRUPT  
 FLAG

MEMORY LOCATIONS &HFF40 TO &HFFBF  
 ARE NOT USED. HUMMMMM! WHAT  
 COULD WE PUT THERE? MORE PIA'S  
 PERHAPS?



(continued from Page 29)

With that purpose in mind, I have prepared an announcement to that effect, and including it along with this letter.

If this copy is acceptable, I would appreciate publication in your next newsletter.

I had the pleasure of meeting your son, Mr. Don H. Garrett, at the "RAINBOWfest". I am sorry I did not have the opportunity to also meet you.

You may be interested to know that our clubs share a pair of distinguished members - Our club president, Dennis Lewandowski, of DSL Computer Products, and Rainbow Magazine, and Kathy Goebel, your own "BASICtalk" Editor.

Dallas R. Cox



MEANDERING CURIOSITY SER

Robert Lockhart, Grand Panjandrum  
 D.H. Fletcher, Chief Poobah

Home Office: 830 Lafayette St.  
 Martinez, California 94553  
 (415) 228-3371

To Whom It May Concern:

Dear Whom:

Though the Chief Poobah and I are only slightly informed when it comes to programming any machine more complicated than a windup stop-watch, we feel that we have come across a nugget of information which should be noted by users of, and programmers for, the TRS80C, AKA CoCo, to wit: START VIDRAM is not always 1536, as stated or implied by such distinguished (actually, Meandering Curiosity has yet to establish conclusively that they are, in fact, distinguished) persons as Messers Inman, Ron Clark, William Barden, Jr. and the writers of certain Tandy manuals.

On May 23 I spoke with a Nice Lady who said she was a member of Radio Shack's Color Computer Group. She advised me that when the group, or any member of it, wants to know START VIDRAM's address for sure, they type:

PRINT PEEK(186)\*256+PEEK(187)

"Aha!" I said, "And depending on the configuration of the system it may or may not return 1536!" "Exactly," she replied, "If you



have a disk system connected it will return 3584, because Disk BASIC uses 1536 to 3583". "That's odd", I rejoined, "It says right here on page 81 of our disk Manual that 1536 to 2440 is used exclusively by Disk BASIC."

It would appear; however, that if, as we are determined to do, we continue to operate our CoCo with the disk drive attached, we will have to add 2048, or  $\&H800$  to the memory addresses specified by Messers Inman in their books, by Mr. Clark in 101 Programming Hints and Tricks and by Mr. Barden, not to mention articles in the various Color Computer Magazines.

We here at Meandering Curiosity are somewhat surprised to find that the CoCoCommunity seems to be so ignorant of the situation as to publish entire books on CoCo programming without mentioning that the addresses cited are valid only for systems of the same configuration as their own.

Be that as it may, Something New has been revealed to us, and in keeping with Meandering Curiosity policy, we hasten to pass it on, in hopes that others may be assisted in their endeavours, and that, if there is more to be known about this matter, we will be informed, one way or another.

Robert P. Lockhart

---

**Editor's Note:** Keeping with this club's newsletter policy we allow the above authors or any other person disagreeing with any of the above to send it to us and it will be published. This is so you the CoCo Users will know the whole story.



---

How do you get an IBM disk Drive to work on the Color Computer?

Patricia Shelton

(continued from Page 44)

the film to the lens and also the distance from lens to the copy, a total distance from film to copy of 40". With lights set on each side of the copy board at 45 degrees and lens set at f16 a BASIC exposure should be determined by shooting the copy in steps of 3 to 5 seconds using a high contrast litho film. When

When the exposure time is established you will now have the BASIC EXPOSURE.

When an enlargement or reduction is desired some changes in the LENS TO FILM (BELLOWS) distance and the lens to copy (COPY DISTANCE), but not necessarily the basic exposure. You can change the f value of the lens or the length of the basic exposure.

Listing 1 calculates all the adjustments from the four inputs below:

1. Lens size in inches ( 4, 4.5, 10, 12, etc.)
2. Size of copy. Width or depth in inches.
3. Desired size. If you want the copy to be reduced from 8" to 6" enter 6.
4. Basic Exposure. This is the time required for making 100% copy. If it was 15 seconds, enter 15.

Listing 2 can be used if you are building a camera and want to make a chart or place a tape on the bellows track and the copy board at the percentage of enlargement or reduction.

I know that this program could be altered to give a print-out to the printer or scrolled a given number of lines at a time. I'm not a programmer and don't know what I'm doing but it works for me and that's what counts.

NEW \* NEW \* NEW \* NEW \* NEW \* NEW \* NEW \* NEW \* NEW \* NEW \* NEW \* NEW \* NEW

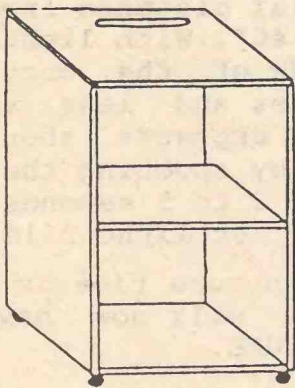

Model ORS-1  
\$ 129.95

These stands are available in one Color only:  
American Walnut

The stands can be covered with formica tops  
and sides for an extra \$ 50 (ORS-3 \$75) and  
the Formica colors are: Walnut and Knot.

Dealer Inquiries Welcome

School & Club Discounts

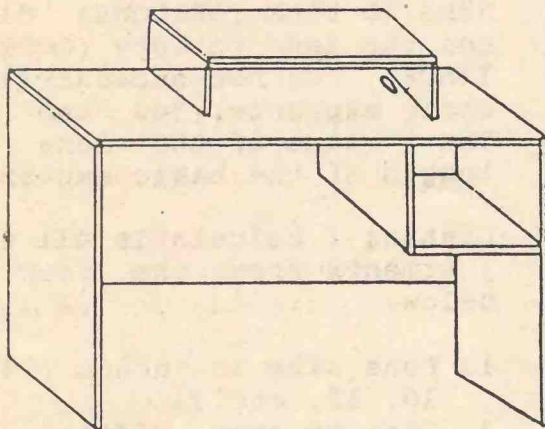

Model ORS-2.....\$ 129.95

Dimensions:

All stands are 27" High

ORS-1 is 24" Wide  
by 24" Deep

ORS-2 is 29" Wide  
by 18" Deep

YOU always wanted something to show you were a color computer owner well here it is:

A LITTLE COLOR COMPUTER LAPEL HN for only \$5.95 (pewter)

Send your order to :

All computer stands are  
Shipped Freight collect  
TX. Residents add 5% sales tax



**PcLEAR4co.**

P. O. BOX 294

HENDERSON, TEXAS 75653-0294

Distributors of Quality Color Computer Equipment

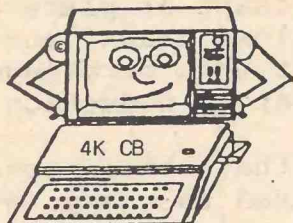

Listing 1

"COPYCAMR"  
1 CLS  
2 PRINT@138,"COPY CAMERA"  
3 PRINT@206,"BY"

PAGE 56

```
4 PRINT@264,"JOSEPH SONGER"
5 PRINT@333,"1983"
6 FOR X=1T0100:NEXT X
10 CLS
20 INPUT"WHAT SIZE LENS IS ON Y
OUR CAMERA";L
30 INPUT"WHAT IS YOUR COPY SIZE
? GIVE WIDTH OR DEPTH";C
40 INPUT"WHAT IS YOUR DESIRED S
IZE";D
50 INPUT"WHAT IS THE BASIC EXPO
SURE";EF
60 FOR X=1T0100:NEXT X
```

(continued on Page 69)

# NEWS RELEASE

WAYNE



Peterborough NH 03458

Contact: James Leonard  
Peterborough, N.H.  
(603) 924-9471

FOR IMMEDIATE RELEASE

## WAYNE GREEN INC. MERGES WITH CW COMMUNICATIONS INC., SUBSIDIARY OF INTERNATIONAL DATA GROUP

In a transaction valued at \$60 million, Wayne Green Inc. of Peterborough, New Hampshire, a leading publisher of magazines, books, and software for the microcomputer user, has merged with CW Communications Inc. of Framingham, Massachusetts, a subsidiary of the International Data Group.

According to the terms of the agreement, the division which currently publishes five microcomputer-related magazines and one amateur radio journal will retain the title, Wayne Green Inc., under the new organization. Mr. Green will continue to serve as president and chief executive officer of the division.

Another division will also be established as Wayne Green Enterprises. This division will pursue new ventures. Plans include the development and publication of new microcomputer-related magazines, and a series of magazines totally unrelated to high technology. Wayne Green Enterprises will also establish a digital laser-disc recording company, and possibly a high tech college in New England.

Instant Software Inc., formerly a subsidiary of Wayne Green Inc., will also join Wayne Green Enterprises. The industry pioneer in the mass production and distribution of software for a variety of micro-computer systems, Instant Software Inc. was recently awarded a contract by The Panasonic Company to be the exclusive supplier of programs for the JR-200U Personal Computer.

Wayne Green will serve as president and chief executive officer of Wayne Green Enterprises, with full control over division funds.

Wayne Green Inc. will continue to publish Microcomputing magazine (covering the personal computer field in general), Desktop Computing (the non-technical magazine for businesspeople), 80 Micro (for Radio Shack computer users), inCider (for Apple computer users), Hot CoCo (for Radio Shack color computer users), and 73 Magazine (for radio amateurs). Wayne Green Inc. will also continue to publish more than 40 microcomputing and amateur radio-related books for novices and experts.

CW Communications Inc. publishes Computerworld, the number one professional/trade publication in the United States according to Folio magazine's "Folio 400" listing, and 22 other computer-related publications in 18 countries.

When asked about the merger, Wayne Green said, "We're pleased and excited about joining forces with CW Communications. Together, we'll be the largest computer publishers in the world. Our combined strengths will allow us to grow as rapidly as the microcomputer industry itself. We're planning a 300% growth this year, beginning with

# DISK COLOR BASIC WORD SEARCH

ZAJJJNJVPDIRROKNBYIJROPYAUFMOSARQIQKPESDMNZXWSIDKZEIJHQYVGGPPDVMQTUHI  
 PXCZGLCBIIYWPWEQZQHRWGSBEDLKWNLYZ\$RQBQMVCFLEJEDEQBAX\$EJVNDL\$ISKAEVIV  
 ZXMFCZNCSZULWYQ\$IUUNIIZHDRIVEOSZG\$NFKIDS\$IBSYQDCDCFWUMKHAUFUXUMKRQKM  
 BGEXOXJAMVRRR\$NOTVYWXRQTPNXDZRTJWOFFDWRUCJKZHO\$LW\$JFRUBDBVUQAVKLIJN  
 ILVIFQYPRLNMCBIOEMQBUGEJTSUPXKBDJRQDDEKFMPUALUBATLFIELDKMGSSVCYRNS  
 TRDDVTYMGVGAEGGCGOEWBZJYERAWEYQQFKLGFSDFRUMPUVFEMZAFTIQQRVCA XUAXUZGEH  
 \$SCPGSAKILLSITWGS\$RHU\$KNHONWRWKKZZ\$CNFVJRDDVAIJVTBARMTKZR\$HXZ\$NXKGEXM  
 ZHKVSEWRWOTKBESWWAWKKQLQFHYBEKZMVAOMG\$ICUDYWFJULRJMAYNPGWNWSUSZIBUUZ  
 \$FILESLVLFWTGWXWQOOLAYDQTSQQPK\$TUZTOZLJNQGGCHPEYKTTSDYFFFUUDRPGYB  
 TIAMDSUUQZCSKMPNDNOISOTLLKOWUCBTEDJBOPBQTURWHIKYUIWAFODMKZOLTDDISSTN  
 FDXFBJSJMTWDQPNBYMCNUWJECNSWKSOZBLKATQEORAWYVXOTTLOADFYCRRDFZQUGGBT  
 YTDIPPWGSUKQGNKLUZYPSSG\$WNYQCJBXZERZYTXXWZZUDNKMXTOKJXRZNAPGTKOQBPB  
 WKCYJJ\$HLRIFGPMTHGGCWCTYWEMMEMAHEZNBXPHJEAZLSETFQPVFRORFZBBFMVUMPDK  
 OQWCTLHE\$FWKBYBRMYDSIMBQQNERRKHKZUMFOXGSDVOQVPHUAGTJIZFEA\$TBYBBLMSN  
 LMERGEDLTZ\$XTEZJDRMSJPVHXWLI\$LCGBICAMQDJGKITZKOHFMJLZLDZQXQBBZBCJCD  
 WAKQPFH\$S\$UERQJG\$WSUEPTTZXDZBUZK\$KVZXDAGXFQCBEFWUASHAJUTKXRYPIJXLXYET  
 QNHQHNIIECS\$RENAMEACSZPOANTAMUBMQGN\$FFTMVYVKMOHAHEYCSUJLQTYPEWDOBGYV  
 BLRCEEXHAAWEDNAEBPDBIGHQHWQEBQKQVLEYVHYTBZVVNMMWARCBXZDGVQJUY\$WBXFHN  
 VCQJ CZM\$FYMLRSETJPBJZTDSOOMRKPOENJNPYBTOYPAQQDNBJIHUQDRHLFPNPAUECMP  
 ZPWE CWGLPUQRADKBCFLYMZKWKXTQIJIAUQRNHOGCCQNHBBQQTIBSWTKFUJBUPXQCPDJ  
 CNUUBJMZYVVFII\$MSORZTJAHLIADXCKPRLPORIOQALDIRHUVFINSAVEVCTHYGQXQ\$EBC  
 RWHOJOKFAFPUIS\$FD\$LDBEJABDMKDYD\$DXLLPVIIEGUCAGVPTZECFLAMOGWPPNVUZSCJWC  
 SHTVJDSIMKIJJPLWCNQERCPVMNRWRITEZXXZFUXOMWINSRPPNX\$IPEKHEZIXBCWQYQVJ  
 DGQQFVGTYEJ\$PSGNVNHZWTDBUYHHCWKHDZ\$FXNKFVLFTTHSNZVWBLANVB TWAGHYAKDFM  
 MISXTQFQAPYBVFIU\$VF\$IFZXDAC\$SSAVTVERIFYZKIYGRMEVCFLFGARYPFITRBECEOLB  
 OCQMIMVXFQOQDGSVNYNHE\$CAHFDNQIKPWATDWEVL YRHVATGOSNRJTKHISRZTOZWNJPF  
 FEIHSSTPMTFOLGKA\$SUPOQGBAEEDCGFFEREFWFGF\$JBP\$AYUNLOAD\$YTQXXHJZJWCshrfoz  
 PXIFCIHKQGTFAAUDHUDUWNQRDBVZGNOEQXZFZLCPITNPD CAMNPF\$SYUXKQJPSIVEN\$ND  
 RQMGNFYRKFSYEP\$VQGGJFVWHEAUKE XWNPYDBD GWOSDSKINIAPK\$LAKQWJGRTONFRYARS  
 RKBZOPGTMHWSZMJJHFKTWSYABJOWCGWUYBCQMFRWTYCVGLVWLLGYJPBDIFGLVWJNJFD  
 EWJNSZGBOUQZZGBACKUPXPORNFDUQKYUBDNERCNQYHHKLBMCSTJVU\$\$PUKSJCNFDTDJQ  
 BLYNQVYKCLGFUCKGYBOPFBHJIYIYASKUWRHYLQYXLGTKBOXRMLYJIOJBNAMOXOBMKJSW  
 QKLSNIAFZFPSS\$GSGBAOXIRXICUWOFDXGAGGGKHOPFYZXFHZZL COPY\$ZVXCZLIFPJKLK  
 QJBIXZSUNWMORB MVILHIBIFAXLXGNZZPPPXFVWUEWLNMTZHQPCMCVPOPHGDUXTFPRLM  
 LZOCQSVAJBFYZMSJNJ VONMTPXDHDSKI\$EOKQRXZG\$SHIHGYKJTS LZ FSLAGZCFSSGAEGH  
 TAHUYXLZAPYGGETFWOCDW\$SUCMPCSZGLPKDHPULGGXLGJZGTRLGHRAKXSWYWUPPLBXZVX  
 KVHLBUOZDREQOIS\$VFJKBLEXJYRBOOTY\$UESIPESVDPDGBDSKOSHZHECFXHAQXVTUPJT  
 SZNPNOIS\$FVCJRKYUBAWUVOTE EHYXGYHSRHEHBKNYYRJMKEBQGUVL YDOBATMYGIDKGBMU  
 MCICVNIQGGKEYXBLWENSXRBITANRGJGLPQPNPBMCSGOKEJQLPVRNCJUSTFCCHBKEHBVPQ  
 AZOVSDYGCHTHLTAGFIPBTOWSFWXIREIAGLWHJGJXGVPUJULWEJFNXNWLLHOLL\$FQJEGH  
 OFTF\$DTLIRXRBOVUHQFOXFVYSWGMKSQDLXBQQPGDXGKASJFREEWNJMTKFSDYWLOQAQBY  
 ZYMZB\$\$ZHJZYPPZFWNSJLVYDJBPTEELCLSWGQLUXCS\$DCPF\$CFSDYEGJLXSRRCCKNS  
 VOEZKVWHTUHD CNGTJIXQXK\$CRRYKUCJNKDAOLOCZJXTJXSECNHLTSTTNEOWEXHVHDIT  
 SUSHFHNNKUGQ\$EUXOYF\$PKOGNYIVLLJFEWSENVNRHNCOMNSNWXMCJJEKRNODJKULUTO  
 QWYSSDCH\$ZADOMSDRQB XVODJUAIEABNXPMZJNHFLOTLGLPQQLOFGYJBFGRBFVTRFROOI  
 WTRUCPEZJKMLCMIPYLXGJBYEMGIOADEOKJBKXJDAAXRDYQLQBWKN\$SOSVQPFIHDDTDE  
 WRRSHMBKLPSEANWBCZXQDSXE\$ITOEAKFTMKN\$YQTWUJOFZKXFWZPXTZJPSNUKP\$CWLQZ  
 UJELTD\$JXESSC\$LWUVWIXQJKZXURMYFWYBZFSAPEIMWQKRMWLD BHSRXJNGQRIGAFEQUQ  
 KOMGYEWSASQFZUDNKCCXMAKAHMSO\$RWKWLNSPTHAORHJQLNBIDFEZTDDLPTZEZBQSPT

The below listed words are all the Disk Basic Commands in this Search!

|       |        |        |        |        |      |        |       |        |      |      |
|-------|--------|--------|--------|--------|------|--------|-------|--------|------|------|
| DIR   | DRIVE  | FIELD  | KILL   | FILES  | LOAD | LSET   | MERGE | RENAME | RSET | SAVE |
| WRITE | VERIFY | UNLOAD | DSKINI | BACKUP | COPY | DSKI\$ | CVN   | FREE   | LOC  |      |
| LOF   | MKN\$  | AS     |        |        |      |        |       |        |      |      |

# INTERNATIONAL COLOR COMPUTER CLUB, Inc. RULES AND BY-LAWS

A NONPROFIT CORPORATION  
2101 East Main Street  
Henderson, Texas 75652

## ARTICLE 1

The principal office of the corporation in the State of Texas shall be located in the City of Henderson, County of Rusk. The corporation may have such other offices; either within or without the State of Texas, as the Board of Directors may determine or as the affairs of the corporation may require from time to time.

The corporation shall have and continuously maintain in the State of Texas a registered office, and a registered agent whose office is identical with such registered office, as required by the Texas Non-Profit Corporation Act. The registered office of the corporation in the State of Texas, and the address of the registered agent may be changed from time to time by the Board of Directors.

## ARTICLE 2

Each individual member shall be entitled to one vote on each matter submitted to a vote of the members.

Any member may resign by filing written resignation with the Secretary, but such resignation shall not relieve the member so resigning of the obligation to pay any dues, assessments, or other charges theretofore accrued and unpaid.

Membership in this corporation is not transferable or assignable.

## ARTICLE 3

An annual meeting of the members shall be held on the first Wednesday in April of each year, beginning with the year 1983, at the hour of 12:00 noon, for the purpose of electing Directors and for the transactions of other business as may come before the meeting. If the day fixed for the annual meeting shall be on a legal holiday in the State of Texas, such meeting shall be held on the next succeeding business day. If the election of Directors shall not be held on the day designated herein for any annual meeting, or at any adjournment thereof, the Board of Directors shall cause the election to be held at a special meeting of the members as soon thereafter as possible.

Special meetings of the members may be called by the President, the Board of Directors, or not less than one-tenth of the members having voting rights.

The Board of Directors may designate any place, either within or without the State of Texas, as the place of meeting for any annual meeting or for any special meeting called by the Board of Directors. If no designation is made or if a special meeting be otherwise called, the place of the meeting shall be the registered office of the corporation in the State of Texas; but if all of the members

shall meet at any time and place, either within or without the State, and consent to the holding of the meeting, such meeting shall be valid without call or notice, and at such meeting, any corporate action may be taken.

Written or printed notice stating the place, day, and hour of any meeting of members shall be delivered, either personally or by mail, to each member entitled to vote at such meeting, not less than ten (10) nor more than fifty (50) days before the date of such meeting, by or at the direction of the President, or the Secretary, or the officers or persons calling the meeting. In case of a special meeting or when required by statute or these bylaws, the purpose or purposes for which the meeting is called shall be stated in the notice. If mailed, the notice of a meeting shall be deemed delivered when deposited in the United States mail addressed to the member at his address as it appears on the records of the corporation, with postage thereon prepaid.

Any action required by law to be taken at a meeting of the members or any action which may be taken at a meeting of the members may be taken without a meeting, if a consent in writing, setting forth the action so taken, shall be signed by all of the members entitled to vote with respect to the subject matter thereof.

Seven (7) members shall constitute a quorum at any meeting of the members. If a quorum is not present at any meeting of members, a majority of the members present may adjourn the meeting from time to time without further notice.

At any meeting of members, a member entitled to vote may vote by proxy executed in writing by the member or by his duly authorized attorney-in-fact. No proxy shall be valid after eleven (11) months from the date of its execution, unless otherwise, provided in the proxy.

Where Directors or officers are to be elected by members such election may be conducted by mail in such manner as the Board of Directors shall determine.

#### ARTICLE 4

The affairs of the corporation shall be managed by its Board of Directors. Directors need not be residents of Texas or members of the corporation. The number of Directors shall be three (3). Each Director shall hold office until the next annual meeting of members and until his successor shall have been elected and qualified.

A regular annual meeting of the Board of Directors shall be held without other notice than this bylaw, immediately after, and at the same place as, the annual meeting of members. The Board of Directors may provide by resolution the time and place, either within or without the State of Texas, for the holding of additional regular meetings of the Board without other notice than such resolution.

Special meetings of the Board of Directors may be called by or at the request of the President or any two Directors. The person or persons authorized to call special meetings of the Board may fix any place, either within or without the State of Texas, as the place for holding any special meetings of the Board called by them.

Notice of any special meeting of the Board of Directors shall be given at least two days previously thereto by written notice delivered personally or sent by mail or telegram to each Director at his address as shown by the records of the Corporation. If mailed, such notice shall be deemed to be delivered when deposited in the United States mail so addressed with postage thereon prepaid.

If notice be given by telegram, such notice shall be deemed to be delivered when the telegram is delivered to the telegraph company. Any Director may waive notice of any meeting. The attendance of a Director at any meeting shall constitute a waiver notice of such meeting, except where a Director attends a meeting for the express purpose of objecting to the transaction of any business because the meeting is not lawfully called or convened. Neither the business to be transacted at, nor the purpose of, any regular or special meeting of the Board of Directors need be specified in the notice or waiver of notice of such meeting, unless specifically required by law or by these bylaws.

A majority of the Directors shall constitute a quorum for the transaction of business at any meeting of the Board; but if less than a majority of the Directors are present at said meeting, a majority of the Directors present may adjourn the meeting from time to time without further notice.

The act of a majority of the Directors present at a meeting at which a quorum is present shall be the act of the Board of Directors, unless the act of a greater number is required by law or by these bylaws.

Any vacancy occurring in the Board of Directors and any directorship to be filled by reason of an increase in the number of Directors, shall be filled by the Board of Directors. A Director elected to fill a vacancy shall be elected for the unexpired term of his predecessor in office.

Directors as such shall not receive any stated salaries for their services, but by resolution of the Board of Directors a fixed sum and expenses of attendance, if any, may be allowed for attendance at each regular or special meeting of the Board; but nothing herein contained shall be construed to preclude any Director from serving the corporation in any other capacity and receiving compensation therefore.

Any action required by law to be taken at a meeting of Directors, or any action which may be taken at a meeting of Directors, may be taken without a meeting if a consent in writing setting forth the action so taken shall be signed by all of the Directors.

#### ARTICLE 5

The officers of the Corporation shall be a President, one or more Vice Presidents (the number thereof to be determined by the Board of Directors), a Secretary, a Treasurer, and such other officers as may be elected in accordance with the provisions of this Article. The Board of Directors may elect or appoint such other officers, including one or more Assistant Secretaries and one or more Assistant-Treasurers, as it shall deem desirable, such officers to have the authority and perform the duties prescribed, from time to time, by the Board of Directors. Any two or more officers may be held by the same person, except the offices of President and Secretary.

The officers of the corporation shall be elected annually by the Board of Directors at the regular annual meeting of the Board of Directors. If the election of officers shall not be held at such meeting, such election of officers shall be held as soon thereafter as conveniently may be. New offices may be created and filled at any meeting of the Board of Directors.

Each officer shall hold office until his successor shall have been duly elected and shall have qualified.



Any officer elected or appointed by the Board of Directors may be removed by the Board of Directors whenever in its judgment the best interests of the corporation would be served thereby, but such removal shall be without prejudice to the contract rights, if any, of the officer so removed.

A vacancy in any office because of death, resignation, disqualification or otherwise, may be filled by the Board of Directors for the unexpired portion of the term.

The President shall be the principal executive officer of the corporation and shall in general supervise and control all of the business and affairs of the corporation. He shall preside at all meetings of the members and of the Board of Directors. He may sign, with the Secretary or any other proper officer of the corporation authorized by the Board of Directors, any deeds, mortgages, bonds, contracts, or other instruments which the Board of Directors have authorized to be executed, except in cases where the signing and execution thereof shall be expressly delegated by the Board of Directors or by these bylaws or by statute to some other officer or agent of the corporation; and in general he shall perform all duties incident to the office of President and such other duties as may be prescribed by the Board of Directors from time to time.

In the absence of the President or in the event of his inability or refusal to act, the Vice President (or in the event there be more than one Vice President, the Vice Presidents in order of their election) shall perform the duties of the President, and when so acting shall have all the powers of and be subject to all restrictions upon the President. Any Vice President shall perform such other duties as from time to time may be assigned to him by the President or the Board of Directors.

If required by the Board of Directors, the Treasurer shall give a bond for the faithful discharge of his duties in such sum and with such surety or sureties as the Board of Directors shall determine. He shall have charge and custody of and be responsible for all funds and securities of the corporation; receive and give receipts for moneys due and payable to the corporation from any source whatsoever, and deposit all such moneys in the name of the corporation in

whatsoever, and deposit all such moneys in the name of the corporation in accordance with the provisions in Article 7 of these bylaws; and in general perform all the duties incident to the office of Treasurer and such other duties as from time to time may be assigned to him by the President or by the Board of Directors.

The Secretary shall keep the minutes of the meetings of the members and of the Board of Directors in one or more books provided for that purpose; give all notices in accordance with the provisions of these bylaws; keep a register of the post-office address of each member which shall be furnished to the Secretary by each member; and in general, perform all duties incident to the office of Secretary and such other duties as from time to time may be assigned to him by the President or by the Board of Directors.

If required by the Board of Directors, the Assistant Treasurers shall give bonds for the faithful discharge of their duties in such sums and with such sureties as the Board of Directors shall determine. The Assistant Treasurers and Assistant Secretaries in general shall perform such duties as shall be assigned to them by the Treasurer or the Secretary or by the President or the Board of Directors.

## ARTICLE 6

Committees not having and exercising the authority of the Board of Directors in the management of the corporation may be designated by a resolution adopted by a majority of the Directors present at a meeting at which a quorum is present. Except as otherwise provided in such resolution, members of each such committee shall be members of the corporation, and the President of the corporation shall appoint the members thereof. Any members thereof may be removed by the person or persons authorized to appoint such member whenever in their judgment the best interests of the corporation shall be served by such removal.

Each member of a committee shall continue as such until the next annual meeting of the members of the corporation and until his successor is appointed, unless the committee shall be sooner terminated, or unless such member shall cease to qualify as a member thereof.

One member of each committee shall be appointed chairman by the person or persons authorized to appoint the members thereof.

Vacancies in the membership of any committee may be filled by appointments made in the same manner as provided in the case of the original appointments.

Unless otherwise provided in the resolution of the Board of Directors designating a committee, a majority of the whole committee shall constitute a quorum and the act of a majority of the members present at a meeting at which a quorum is present shall be the act of the committee.

Each committee may adopt rules for its own government not inconsistent with these bylaws or with rules adopted by the Board of Directors.

## ARTICLE 7

The Board of Directors may authorize any officer or officers, agent or agents of the corporation, the addition to the officers so authorized by these bylaws, to enter into any contract of execute and deliver any instrument in the name of and on behalf of the corporation. Such authority may be general or confined to specific instances.

All checks, drafts, or orders for the payment of money, notes, or other evidences of indebtedness issued in the name of the corporation shall be signed by such officer or officers, agent or agents of the corporation and in such manner as shall from time to time be determined by resolution of the Board of Directors. In the absence of such determination by the Board of Directors, such instruments shall be signed by the Treasurer or an Assistant Treasurer and countersigned by the President or a Vice President of the corporation.

All funds of the corporation shall be deposited from time to time to the credit of the corporation in such banks, trust companies, or other depositaries as the Board of Directors may select.

The Board of Directors may accept on behalf of the corporation any contribution, gift, bequest, or devise for the general purposes or for any special purpose of the corporation.

## ARTICLE 8

The Board of Directors may provide for the issuance of certificates evidencing

membership in the corporation, which shall be in such form as may be determined by the Board. Such certificates shall be signed by the President or a Vice President and by the Secretary or an Assistant Secretary and shall be sealed with the seal of the corporation. All certificates evidencing membership shall be consecutively numbered. The name and address of each member and the date of issuance of the certificate shall be entered on the records of the corporation. If any certificate shall become lost, mutilated, or destroyed, a new certificate may be issued therefor on such terms and conditions as the Board of Directors may determine.

When a member has been approved and has paid any initiation fee and dues that may then be required, a certificate of membership shall be issued in his name and delivered to him by the Secretary, if the Board of Directors shall have provided for the issuance of certificates of membership under the provisions contained in this Article 8.

#### ARTICLE 9

The corporation shall keep correct and complete books and records of account and shall also keep minutes of the proceedings of its members, Board of Directors, and committees having any of the authority of the Board of Directors, and shall keep at the registered office or principal office a record giving the names and addresses of the members entitled to vote. All books and records of the corporation may be inspected by any member or his agent or attorney for any purpose at any reasonable time.

#### ARTICLE 10

The fiscal year of the corporation shall begin on the first day of January and end on the last day of December in each year.

#### ARTICLE 11

The Board of Directors may determine from time to time the amount of initiation fee, if any, and the annual dues payable to the corporation by members.

Dues shall be payable in advance on a date determined by the Board of Directors and communicated to the members.

When any member shall be in default of payment of dues for a period of two months from the date such dues are due and payable, his membership may thereupon be terminated by the Board of Directors in the manner provided.

#### ARTICLE 12

The Board of Directors shall provide a corporate seal which shall be in the form of a circle and shall have inscribed thereon the name of the corporation and the words "Corporate Seal of International Color Computer Club, Inc."

Whenever any notice is required to be given under the provisions of the Texas Non-Profit Corporation Act or under the provisions of the article of incorporation or the Bylaws of the corporation, a waiver thereof in writing signed by the person or persons entitled to such notice, whether before or after the time stated therein, shall be deemed equivalent to the giving of such notice.

## ARTICLE 13

These bylaws may be altered, amended, or repealed and new bylaws may be adopted by a majority of the Directors present at any regular meeting or at any special meeting, if at least two days, written notice is given of an intention to alter, amend, or repeal these bylaws or to adopt new bylaws at such meeting.

## ARTICLE 14

Notwithstanding anything herein to the contrary, all action taken by the Board of Directors shall be subject to the approval of the membership.

## ARTICLE 15

Notwithstanding anything herein to the contrary, the rules and regulations of the International Color Computer Club are adopted and incorporated into these bylaws by reference for all purposes where the same are not in conflict herewith. See below attached hereto and incorporated herein by reference for all purposes.

### International Color Computer Club Rules And Regulations

#### 1. LIBRARY RULES:

- A). Members will be responsible for library selections which they check out (books & ROMpacks) and will re-imburse the club for loss or damage occurring while in the members possession.
- B). A fee of \$2.00 per selection will be required to check out programs, books and ROMpacks from the library. The fee is to cover cost of the tape and postage for programs, and to cover postage (both ways) for books and ROMpacks.
- C). Any programs submitted to the library must not infringe on the copyrights of anyone else. (They must be original)
- D). Every member must contribute something to the library.

#### 2. PARTS LIBRARY:

Members who borrow parts for his/her computer promises to repay the club with like parts within 90 days or pay for the parts in cash.

3. The International Color Computer Club, Inc. cannot be held responsible for the actions of any single member, with the exception of it's officers.
4. Members may place advertisements for any computer related item in the newsletter (up to  $\frac{1}{4}$  page ad (Classified style)) FREE. For display ads and larger ads the normal rate less 25% applies.
5. Any outside advertising, additions or deletions to or for the club must be done by the President, Vice President or Secretary or must be cleared by them before being implemented.
6. There shall be no qualifications for joining the club other than agreeing to obey the rules, paying the dues and being interested.
7. Club funds may not be spent on anything other than club operation.
8. The membership dues cannot be raised to those who are already members.
9. If a member decides to drop out of the club, for whatever reason, no refunds will be given.
10. Submissions of software to the club for review will never be copied.
11. A vote shall be binding if it receives ANY majority of those who send in their ballots.
12. In order for a vote to be counted, it must be received on or before the first of the month following newsletter publication. Example: for Jan/Feb issue the ballot must be returned on or before February 1st.
13. It is mandatory to call a vote on an issue if we have 5 or more requests



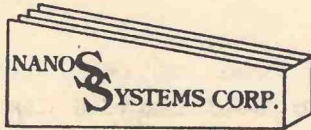

**System Reference Cards  
FOR THE  
MICROCOMPUTER**

# NEWS RELEASE

Microcomputers are used more and more in the classroom and the home than ever before. Along with the microcomputers comes the news that some things are hard to find and difficult to use.

One of the problems is finding documentation which can be easily used by the student or homeowner which tells him or her about the computer. Our corporation realizes that books for everyone may be difficult to obtain because of price, and because sometimes a single book does not contain information in a format conducive to learning.

We have created what are known in the industry as System Reference Cards. We currently have them for the TRS-80, Model I, II, III, Color Computer, and Pocket Computer. We also have them for the Apple II and II Plus Computers. In the near future we will have them for the Pet, Heathkit, Atari, and others.

What are they? Fundamentally they completely summarize the microcomputer, its functions and Basic statements, commands, and everything you might need to reference in order to use the computer. They provide a quick-reference to nearly everything about the computer.

They are fold-up accordion-style cards, 8½ by 3¼, printed on 80 lb. Beckett cover stock or similar material, and, they fit in a shirt pocket.

They can be used in lieu of the manuals, and can be taken home

PAGE 68

for study, and, they are great in the classroom. Easily affordable, they allow the teacher or instructor to have material for each person studying the computer.

We have special prices available for educational institutions, & indeed, they are being used by everyone today.

If you are interested, we have the following cards available:

| <u>CARD</u>            | <u>Special Price</u> |
|------------------------|----------------------|
| TRS-80 MODEL I BASIC   | \$ 2.00              |
| TRS-80 MODEL III BASIC | \$ 2.50              |
| TRS-80 Color Computer  | \$ 3.10              |

These prices are only good if the orders are sent by the club in one bulk order. So individual members must send your order to the club and they will place the order for you.

These are quality cards, and a great effort was made to make them easy to read and use. We know that any solicitation by mail are questionable these days but we would like to assure you that this offer is an honest offer of a truly quality product at a real-value price.

You may order or inquire to:

ICCC, Inc. - NANOS Offer  
ATTN: Secretary  
2101 East Main St.  
Henderson, Texas 75652

We pay shipping and handling for your order if you send a check with your order.

If you prefer to simply make an inquiry, we will answer you by phone or mail.

Who are we?

We are Paul and Shirley Nanos. One of us works with computers & the other is a typesetter. We are a team with the goal of documenting as much of the flood of microcomputer information as we can so that you the user will be able to do much more sooner, and in a way which is comprehensive & quick.

Please try our product. You will like it.

Thank You So Much For Your Time,



*Paul P. Nanos*

**Editor's Note:** DO NOT TRY TO ORDER ANY OF THE ABOVE SYSTEMS REFERENCE CARDS DIRECT!!!!  
There will be a little delay in orders placed in this way but it is worth the savings!!

```

70 CLS
80 R=D/C
90 B=L*(R+1)
100 A=L*(1+1/R)
110 F=(32*L)/B
120 T=(R+1*R+1)/4*EF
130 PRINT"FILM TO LENS DISTANCE
="B"INCHES"
140 PRINT"LENS TO COPY DISTANCE
="A"INCHES"
150 PRINT"YOUR RATION IS "R
160 PRINT"F="F" & EXPOSE "EF"
SECONDS"
170 PRINT"OR F=16 & EXPOSE "T"
SECONDS"
180 GOTO 180

```

a new magazine in January."

Patrick J. McGovern, chairman of the board of CW Communications Inc., comments, "The personal computer field is the fastest growing part of the high tech industry. We're proud to have the publications of Wayne Green Inc. as part of our global publications family. They are pioneers and leaders in their field."

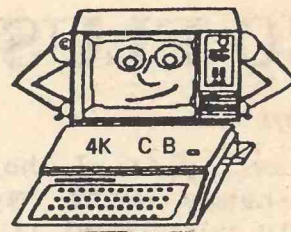

Listing 2

```

"CAMERA"
10 CLS
20 PRINT"CAMERA BY JOSEPH SONGE
R"
30 FOR X=1TO800
40 INPUT"WHAT SIZE LENS IS ON Y
OUR CAMERA";L
50 INPUT"PERCENT DESIRED (USE D
ECIMAL .50)";R
60 BE=L*(R+1)
70 CE=L*(1+1/R)
80 D=BE+CE
90 PRINT"RATIO="R,"BELLOWS="BE
100 PRINT"LEN-COPY="CE,"TAPE="D

110 PRINT"*****
*****"
120 PRINT" A TAPE STARTS AT THE
FILM AND CONTINUES PAST COPY
"
130 PRINT"FILM", "LENS COPY
"
140 PRINT"O",BE "D
150 PRINT"*", "*" "*"

160 FOR I=0TO D STEP 10
170 PRINT I;
180 NEXT I
190 END

```



# # # # # # # # # # #



# VIDEO PLUS Review

by Frederick Boyd

For the last year I have been extremely happy with my COCO. I originally purchased it because it was inexpensive, but later learned to appreciate its advance capabilities. As I became more experienced, two features increasingly bothered me: first the keyboard looks like a toy or a cheap calculator; and second, the TV output was difficult to read in any of the high resolution programs. After buying a real keyboard, I had to deal only with the fuzzy TV image; that's where VIDEO PLUS comes in.

VIDEO PLUS is a hardware product which allows use of a real computer monitor. Installation could not be simpler. After carefully removing the computer top, the RF shield must also be removed. Next, remove the 1372 chip, insert it into VIDEO PLUS's socket, and insert the socket into the mother board. If you wish to retain sound capabilities, next clip a connector to the specific wire inside the computer. DONE! No soldering or wire wrapping. Couldn't be easier.

The monitor is connected via one of the two new wires from the back of the computer; an external amplifier may be connected to the other. The TV may still be used if desired. I use the monochrome monitor for all word or number oriented programs and the TV when color is needed for games.

The monitor is a razor sharp, clean screen. I chose an Apple monitor (green) but any monitor may be used. In the 32 character mode, reading is a dream... no confusion between 1 and I or 0 and O. In the 51 character mode everything seems normal. Even the 64 character mode is a breeze.

PAGE 70

With ever increasing sophistication of software, and more and more programs offering high resolution screens, a crisp image is a necessity. VIDEO PLUS and a good monitor will supply this. At \$24.95, it is a bargain.



## It Is Here!!

A Color Computer pin is now available for all you Color Computer owners. You can now show that you are a Color Computer owner for a little amount of money.

This is a pewter Lapel-type pin precision made and of high quality.

We have one available that is just the computer and the screen and one for the ICCC, Inc. members. Below are pictures of what both of them look like:

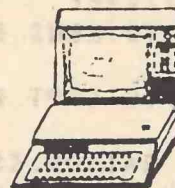

This pin sales for only \$5.95 each + .50¢ S&H (\$4.45 to all CoCo clubs)

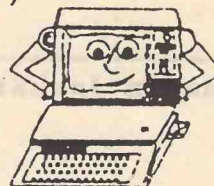

This pin is only available if you are and ICCC, Inc. member since this logo is copyrighted. The price to the ICCC, Inc. member is \$5.00 each + .50¢ S&H

Send your order to:



**PcLEAR4co.**

P. O. BOX 294

HENDERSON, TEXAS 75653-0294

Distributors of Quality Color Computer Equipment



# MINUTES of the Board of Directors Meeting

MINUTES OF THE FIRST MEETING OF THE  
BOARD OF DIRECTORS OF INTERNATIONAL COLOR COMPUTER CLUB, INC.

A TEXAS CORPORATION

The following are the minutes of the first meeting of the Board of Directors of INTERNATIONAL COLOR COMPUTER CLUB, INC., a Texas corporation, held at the Holiday Inn on Highway 259 South, Henderson, Rusk County, Texas, on the 6th day of April, 1983, at 12:00 noon, said meeting have been held on the call of all of the incorporators named in the Articles of Incorporation.

Present at the meeting were RONALD L. GARRETT, DONALD H. GARRETT and BETTY GARRETT, who are the persons named as initial Directors of the corporation in its Articles of Incorporation filed with the Texas Secretary of State on April 4, 1983.

These directors are all of the Directors authorized by and named in the Articles of Incorporation.

A document of 8 numbered pages plus one exhibit entitled BYLAWS OF INTERNATIONAL COLOR COMPUTER CLUB, INC." was then presented to and considered by the meeting. After a review of such bylaws and a discussion of particular parts thereof, on motion duly made and seconded, it was unanimously

RESOLVED, that the bylaws presented to and considered at this meeting are adopted as the bylaws of this corporation and the Secretary of the corporation is ordered to certify a copy of such bylaws and insert them in the minute book of the corporation; the Secretary is further ordered to certify a copy of such bylaws and maintain them in the principal office of the corporation for the transaction of its business and open for inspection by the members at all reasonable times during office hours.

The format for a corporate seal was presented to the meeting and on motion duly made and seconded, it was unanimously:

RESOLVED, that a corporate seal, consisting of two (2) concentric circles containing the words "INTERNATIONAL COLOR COMPUTER CLUB, INC.", "TEXAS," and in the center of such circles the word "Incorporated" together with the date of incorporation of this corporation, is adopted as the corporate seal of the corporation, and the Secretary is instructed to impress such seal on the minutes of this meeting opposite the place where this resolution appears.

Motion was made and duly seconded that CARL H. BARBER act as the attorney for the corporation, and it was unanimously

RESOLVED, that CARL H. BARBER will act in the capacity of attorney for the corporation and reasonable compensation as payment for his services is authorized.

Temporary officers were elected by acclamation, such being

PRESIDENT - Ronald L. Garrett  
VICE PRESIDENT - Betty Garrett  
SECRETARY - Donald H. Garrett  
TREASURER - Jackie Leuschner

To provide for a depository for the funds of this corporation, and to authorize certain officers to deal with corporate funds, the following resolution was adopted:

SEE EXHIBIT "A" ATTACHED HERETO AND INCORPORATED HEREIN BY REFERENCE.

In order to provide for the payment of the expenses of incorporation and organization of this corporation, on motion made, seconded and unanimously carried, the following resolution was adopted:

RESOLVED, that the Treasurer of this corporation be, and she is hereby authorized and directed to pay the expenses of incorporation and organization of this corporation.

RESOLVED, that the following slate of individuals be presented to the membership of the International Color Computer Club, Inc., the three (3) of which receive the most votes will serve as directors of said club.

RESOLVED, that International Color Computer Club, Inc. shall assume and pay any and all debts of of Internation Color Computer Club incurred before the date of incorporation.

RESOLVED, that International Color Computer Club, Inc. ratifies and adopts all agreements, obligations, rules and guidelines of International Color Computer Club insofar as the same does not conflict with the Articles of Incorporation, By-Laws and the laws of the State of Texas.

RESOLVED, that International Color Computer Club, Inc. shall issue certificates of membership to all individuals already members of International

Color Computer Club on the date of incorporation as well as issuing membership certificates to those individuals who join after the date of incorporation.

RESOLVED, that International Color Computer Club, Inc. is authorized to purchase and take possession of all of the assets of International Color Computer Club.

Respectfully submitted,

Don H. Garrett  
Secretary

APPROVED:

\_\_\_\_\_  
President



# The New TRS-80 Micro Color Computer

by Linda Miller

**TRS-80 Microcomputer News**  
Volume 5      JUNE 1983  
Issue 6

TRS-80 Microcomputer News is published monthly by Radio Shack, a division of Tandy Corporation, One Tandy Center, Fort Worth, Texas U.S.A. 76102. Copyright 1983 by Tandy Corporation, One Tandy Center, Fort Worth, Texas U.S.A. 76102. All rights reserved.

Reproduction or use, without express written permission from Tandy Corporation, of any portion of the Microcomputer News is prohibited. Permission is specifically granted to individuals to use or reproduce material for their personal, non-commercial use. Reprint permission for all material (other than Ivan Sygoda's Profile article), with notice of source, is also specifically granted to non-profit clubs, organizations, educational institutions, and newsletters.

The TRS-80 Micro Color Computer Model MC-10 offers graphics capability and BASIC programming in a compact, inexpensive unit. Some outstanding features of the MC-10 are:

- A keyboard with keys that move when pressed. This is not a membrane keyboard.
- A built-in RS-232 serial port for communications or for connecting other serial devices such as serial printers or plotters.
- Keyword input using two simple keystrokes.
- Low resolution graphics in a 64 x 32 matrix.
- Sound. Create your own music or sound effects.
- Microsoft Color BASIC

The MC-10 is approximately 8 1/2" wide by 7" deep by 2" high. It has 48 keys and can be connected to a TV (preferably color) via its own antenna switch. A power supply and a well written, easy to understand manual are also supplied with the Micro Color Computer. The suggested retail price for the computer is \$119.95.

## THE KEYBOARD

The MC-10 has a "QWERTY" keyboard with keys that move (travel) when pressed. Above thirty-seven of the keys are familiar BASIC words and functions. Many keys have two characters on the key cap much like a typewriter keyboard. Graphic characters are located on the alphabetic keys Q, W, E, R, T, Y, A, S, D, F, G, Z, X, C, or V. The second characters which appear above or to the right side of the primary character are created by pressing (SHIFT) and the character key. To create the graphic character on the A key, press

(SHIFT) (A) and the graphic character  appears on the screen.

Above other keys are commands (L, DEL, arrow keys) and BASIC words. The commands and BASIC words can be duplicated by pressing the (CONTROL) key and the key below the desired word. To enter RESTORE from the keyboard, press (CONTROL) (Y) and RESTORE appears on the screen. Keyword input in this manner makes for faster program entry.

Special instructions are located on the Q, A, W, S, and Z keys. (CONTROL) (A) is the backspace instruction; (CONTROL) (Q) deletes the entire current program line, (CONTROL) (W) generates an up arrow which is the exponentiation operator, and (CONTROL) (S), (CONTROL) (Z) (I) are reserved for special purposes.

(SHIFT) (O) toggles the computer back and forth between upper and lower case. The lower case characters appear as reverse-video, upper-case characters on the screen but print on paper in lower case.

## THE MC-10 HAS CONNECTIONS AND MEMORY

On the back of the MC-10 are a cassette recorder connector, a slot for future memory expansion kits, a RESET button, and an RS-232 connector so the MC-10 can be used with serial devices including modems and Radio Shack's serial printers or plotters.

The MC-10 can store over 3K bytes in RAM for user access at a single time. When the power is turned off, the memory is erased. For permanent storage, programs and data must be written to cassette tape.

## ERROR MESSAGES

The MC-10 displays a full range of error messages—19 in all—in response to programming mistakes.

## ADD A LITTLE COLOR TO YOUR LIFE

There are nine distinct colors that can be generated with the MC-10.

| Color   | Code |
|---------|------|
| Black   | 0    |
| Green   | 1    |
| Yellow  | 2    |
| Blue    | 3    |
| Red     | 4    |
| Buff    | 5    |
| Cyan    | 6    |
| Magenta | 7    |
| Orange  | 8    |

Each of the 16 graphic characters may be displayed with a different background color. When (CONTROL) (O) is pressed, the cursor changes colors, and the new color be-  
(continued on Page 77)

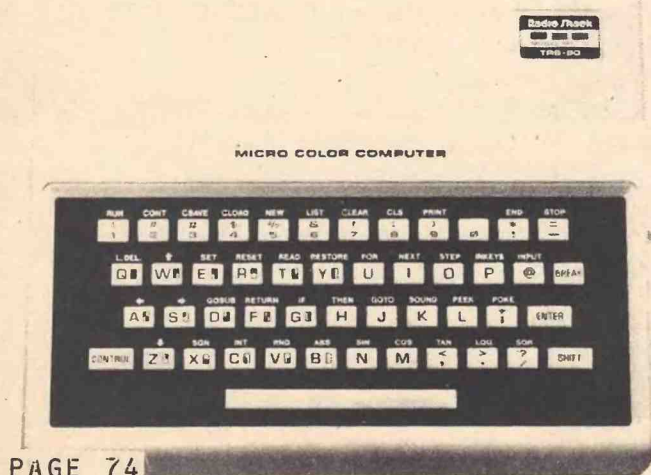

# Association Document

## MEMBERSHIP AGREEMENT

STATE OF TEXAS        §

COUNTY OF RUSK       §

AGREEMENT made the effective date shown below by and between INTERNATIONAL COLOR COMPUTER CLUB, INC, a non-profit corporation, hereinafter called CLUB, and

\_\_\_\_\_, hereinafter called AFFILIATE.

For and in consideration of ONE AND NO/100 DOLLAR (\$1.00) and other valuable consideration and the mutual promises and covenants contained herein the parties hereto agree as follow, to-wit:

1. The AFFILIATE shall share in the benefits of the CLUB's large library assembled from members worldwide.
2. The AFFILIATE shall share in all discounts granted to members of the CLUB.
3. The AFFILIATE may use the newsletter of the CLUB to publish its materials, thereby reducing or eliminating the strain of printing its own newsletter, at the option of the AFFILIATE.
4. The AFFILIATE will have and enjoy all benefits of membership in the CLUB.
5. The AFFILIATE will benefit from a lower membership fee than if the AFFILIATE's members joined the CLUB individually.
6. The CLUB will offer assistance to the AFFILIATE in organizing local clubs and programs specifically designed for club use.
7. The AFFILIATE will submit its library to be included in the main library of the CLUB.
8. The AFFILIATE will include the words "a subsidiary of INTERNATIONAL COLOR COMPUTER CLUB, INC." on all advertising and newsletters.
9. The AFFILIATE agrees to obey all rules and regulations of INTERNATIONAL COLOR COMPUTER CLUB, INC. in effect or that may be hereafter adopted.
10. The AFFILIATE agrees that all members of the local club must become members of the INTERNATIONAL COLOR COMPUTER CLUB, INC. at the reduced rates provided for in this agreement.
11. The parties hereto agree that if all requirements for membership by the AFFILIATE are met, the membership fee for each member of the local club shall be \$ \_\_\_\_\_ per year. There is a minimum requirement of ten (10) members for each affiliate.

12. This agreement shall be effective as of the \_\_\_\_\_ day of \_\_\_\_\_, 19\_\_\_\_.

13. The parties hereto agree that jurisdiction and venue of any action arising concerning the terms or subject matter of this agreement shall be in Rusk County, Texas, U.S.A. and that all matters made the subject of this agreement shall be governed by the laws of that state.

14. The parties hereto agree that if the membership of an Affiliate drops below ten (10) members then the benefits of such affiliation is lost and this agreement is of no further force and effect. The members in this case must then acquire any continued membership in International Color Computer Club, Inc. on an individual basis.

SIGNED this \_\_\_\_\_ day of \_\_\_\_\_, 19\_\_\_\_, by

INTERNATIONAL COLOR COMPUTER CLUB, INC.

BY:

\_\_\_\_\_  
President

ATTEST:

\_\_\_\_\_  
(Asst.) Secretary

SIGNED this \_\_\_\_\_ day of \_\_\_\_\_, 19\_\_\_\_, by

\_\_\_\_\_  
Affiliate



(continued from Page 74)

comes the background color for the next graphic character. Printing CHR\$(128) through 255 will display the 16 character graphic characters in all eight possible colors. Graphic characters can also be entered directly from the keyboard. Pressing **(SHIFT)** and the key with the selected graphic character, displays the character on the screen. In program lines, the graphic character is enclosed in quotation marks.

```
10 PRINT"█"
```

### DO I HEAR MUSIC?

The Micro Color Computer is able to control and program the sound which comes from the TV's speaker. Volume is adjusted on the TV, and pitch and duration are controlled with the BASIC SOUND statement:

**SOUND pitch-code, duration (ENTER)**

Pitch-code can be any number from 1 to 255 with 1 being the lowest and 255 the highest pitch. Duration is any number from 1 to 255, and duration is specified in units of .06 seconds. SOUND 39,10 produces middle-C for .6 of a second.

### ARRAYS

The MC-10 supports both single and double dimensioned arrays. Arrays that have more than 10 elements need to be dimensioned using the DIM statement.

### USING A CASSETTE

The cassette baud rate is 1500. This is a transfer rate of approximately 190 characters per second or 11,000 characters per minute.

Programs can be saved to (CSAVE) or loaded from (CLOAD) cassette. The contents of an array are saved to cassette using CSAVE\* and loaded back into memory from cassette using CLOAD\*.

SKIPF searches for a program previously saved to tape.

### THE MC-10 AS A CALCULATOR

Like other computers, the MC-10 can be used as a number cruncher. It adds (+), subtracts (-), multiplies (x), and divides (/) and performs mathematic functions.

### RELATIONAL AND LOGICAL OPERATORS

The relational operators are:

| Operator | Function                    |
|----------|-----------------------------|
| >        | Is greater than             |
| <        | Is less than                |
| =        | Is equal to                 |
| <>       | Is not equal to             |
| <=       | Is less than or equal to    |
| >=       | Is greater than or equal to |

Logical operators test values to see if they are true (on) or false (off). The logical operators AND, OR, and NOT can be used in conjunction with IF . . . THEN to perform true/false tests.

### STRING AND NUMERIC VARIABLES

The MC-10 handles two types of variables: numeric and string. Numeric variables are designated by any two character combination as long as the first character is a letter and the second character is a letter or a number.

String variables are formed the same way as numeric variables with the addition of a dollar (\$) sign to indicate a

string variable. String variables can be added (concatenated) together as in the example below.

```
NAME$ = FIRST$ + MIDDLE$ + LAST$.
```

### THE MICRO COLOR BASIC DIALECT

| BASIC IN THE MICRO COLOR COMPUTER |                 |           |
|-----------------------------------|-----------------|-----------|
| ABS                               | IF/THEN         | PRINT TAB |
| ASC                               | INKEY\$         | PRINT@    |
| ATN                               | INPUT           | READ      |
| CHR\$( )                          | LEFT\$          | REM       |
| CLEAR                             | LEN             | RESET     |
| CLOAD                             | LET             | RESTORE   |
| CLOAD*                            | LIST            | RIGHT\$   |
| CLS                               | LLIST           | RND       |
| CONT                              | LOG             | RUN       |
| COS                               | LPRINT          | SET       |
| CSAVE                             | MEM             | SGN       |
| CSAVE*                            | MID\$           | SIN       |
| DATA                              | NEW             | SKIPF     |
| DIM                               | ON/GOSUB/RETURN | SOUND     |
| END                               | ON/GOTO         | SQR       |
| EXP                               | PEEK            | STOP      |
| FOR/TO/STEP NEXT                  | POINT           | STR\$     |
| GOSUB/RETURN                      | POKE†           | TAN       |
| GOTO                              | PRINT           | VAL       |

†POKE may be used for addresses in video RAM only.

### YOU SAY YOU WANT FRIENDLY?

The Micro Color Computer (Model MC-10) has color, graphics, sound, a real keyboard—in short, a lot for its remarkably low price. The combination of affordability, power, and easily understood documentation make this unique computer friendly to all including the first time user.

### Product Flash ! !

While prices last ( and they just increased ) and while supplies last (Electronic Buyers' News predicts a 1983 mid-summer shortage) HAWG WILD Software will sell first-run, prime RAM chips for your Coco at the following, unbelievable prices :

1 x 16K only \$2.00 each

1 x 64K only \$6.00 each

You will need eight (8) to upgrade your RAM. Include \$1.00 P & H. Arkansas residents add 4% tax. No additional 10% discount on this offer. Prices subject to change or withdrawl without notice.

Sincerely,  
Gary Smith

**HAWG WILD Software**  
P. O. Box 7668  
Little Rock, AR 72217

# CLASSIFIED ADVERTISEMENTS

WANTED\*\*\*\*\* WANTED\*\*\*\*\*

A program to run the Home Control Commands for the Home Controller. Needs to be on disk. Willing to pay Top dollar for it. Negotiations can be made.

Desperate Member

\*\*\*\*\*

## SOFTWARE SELL-OUT

I have some software to get rid of at cheap prices. First come, first served.

GALACTIC ATTACK = \$15, PAC ATTACK = \$12, DUNKEY MUNKEY = \$15, STORM = \$12, SKY DEFENSE = \$8, MARS ADVENTURE = \$4, POLARIS = \$13, and STORM ARROWS = \$17.

Send \$1 shipping to: Mike Anheluk 38465 Place Road, Fall Creek, OR 97438.

\*\*\*\*\*

\$\$\$\$\$\$\$\$\$\$\$\$\$\$\$\$\$\$\$\$\$\$\$\$\$\$\$\$\$\$\$\$\$\$\$\$\$\$\$\$

I am interested in starting a Software/Hardware business. Please send me information on becoming a Dealer/Distributor for your products along with price lists and product descriptions. Send to: Art Hotes, 1200 Mulberry Lane, Brunswick, Ohio 44212.

\$\$\$\$\$\$\$\$\$\$\$\$\$\$\$\$\$\$\$\$\$\$\$\$\$\$\$\$\$\$\$\$\$\$\$\$\$\$\$\$

@@@@@@@@@@@@@@@@@@@@@@@@@@@@@@@@@@@@@@@@

New Software with High Resolution Graphics (requires 32K Extended). Buy 1 for \$10.00 and get 1 FREE! Shuffleboard, Bingo, Monopoly, Black Jack, and Five in a row. Send orders to: Ronald Tambllyn, RR # 3, Bowmanville, Ontario L1C-3K4 -- CANADA.

@@@@@@@@@@@@@@@@@@@@@@@@@@@@@@@@@@@@@@@@

FOR SALE -- 1 Radio Shack DMP 100 Printer (Used 4 months). Comes with Dust Cover and 1 New & 1 Used Ribbon Cartridge

and RS Color Scripsit Cartridge. Cost is \$325.00-Includes shipping & Insurance. For more information call: Peter B. Howell, 19 Dubois Road, New Paltz, N.Y. 12561. (914) 255-1737.

\*\*\*\*\*

\$\$\$\$\$\$\$\$\$\$\$\$\$\$\$\$\$\$\$\$\$\$\$\$\$\$\$\$\$\$\$\$\$\$\$\$\$\$\$\$

I have a TRS-80 Color Computer 32K Ext. Basic. I am interested in a disk system. I am looking for a used disk system in fairly good condition. Contact: Jim Bennington, 811 Early Forest Circle, Sandston, VA 23150.

\$\$\$\$\$\$\$\$\$\$\$\$\$\$\$\$\$\$\$\$\$\$\$\$\$\$\$\$\$\$\$\$\$\$\$\$\$\$\$\$

+++++

FOR SALE -- Line Printer VII (same as DMP100) in like new condition, used 1 year.... Also included: Two New ribbons and Radio Shack's 'Spectaculator' & 'Scripsit' Programs (ROMpacks). Would cost \$496.80 if purchased new; will sell for \$200 including shipping/insurance. Contact: John Livernash, 1517 Foster Dr., Reno NV 89509, (702) 329-0542.

+++++

\*\*\*\*\*

I am looking for an Assembly Language Programming book for 6809 microprocessors. I will trade these programs: Joystick (or Keyboard), Four (like connect four), Magazine File, & a Yahtzee type game or the book Color Computer Graphics by William Barden, Jr. I will also take offers to buy a book. Please write with what you want for the book, and the name of the book. THANK YOU!!!

Tony Wyland, 103 Sunset View Drive, New Cumberland, PA 17070.

\*\*\*\*\*

\$\$\$\$\$\$\$\$\$\$\$\$\$\$\$\$\$\$\$\$\$\$\$\$\$\$\$\$\$\$\$\$\$\$\$\$\$\$\$\$

I HAVE ONE Color Computer Learning Lab by Radio Shack to sell. Complete folder with 8 tapes and 233 page manual.A-1 Condition Sells for \$49.95--Yours for



# INTERNATIONAL COLOR COMPUTER CLUB, INC.

Main Office  
2101 E. Main St., Henderson, Texas 75652  
Canadian Branch  
P.O. Box 7498, Saskatoon, SK S7K-4L4

MEM # \_\_\_\_\_

FOR OFFICE USE ONLY

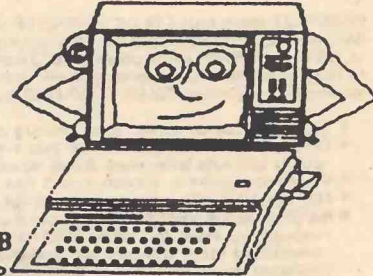

WORLD'S LARGEST COLOR COMPUTER CLUB  
APPLICATION FOR MEMBERSHIP

NAME \_\_\_\_\_ ADDRESS \_\_\_\_\_

CITY \_\_\_\_\_ STATE \_\_\_\_\_ ZIP \_\_\_\_\_

PHONE \_\_\_\_\_ DATE \_\_\_\_\_

ARE THERE ANY OTHER MEMBERS OF YOUR FAMILY THAT ARE INTERESTED IN COMPUTERS? \_\_\_\_\_

HOW LONG HAVE YOU WORKED COMPUTERS? \_\_\_\_\_ HOW LONG WITH A COLOR COMPUTER? \_\_\_\_\_

DO YOU HAVE A PRINTER? \_\_\_\_\_ A MODEM? \_\_\_\_\_ A DISK? \_\_\_\_\_ WHAT BRAND DISK? \_\_\_\_\_

HOW MUCH MEMORY DOES YOUR COMPUTER HAVE? \_\_\_\_\_ DO YOU HAVE EXTENDED BASIC? \_\_\_\_\_

HAVE YOU WRITTEN ANY PROGRAMS? \_\_\_\_\_ WOULD YOU SHARE THEM WITH OTHER MEMBERS? \_\_\_\_\_

ARE THESE PROGRAMS GAMES OR BUSINESS PROGRAMS? \_\_\_\_\_ ORIGINAL? \_\_\_\_\_

HAVE YOU HAD ANY EXPERIENCE WITH ASSEMBLY LANGUAGE FOR THE 6809 PROCESSOR? \_\_\_\_\_

WHAT WAS YOUR PRIMARY REASON FOR BUYING A COLOR COMPUTER? GAMES \_\_\_\_\_ BUSINESS \_\_\_\_\_

PLEASE LIST THE PROGRAMS YOU HAVE WRITTEN 1. \_\_\_\_\_ 2. \_\_\_\_\_ 3. \_\_\_\_\_

4. \_\_\_\_\_ 5. \_\_\_\_\_ 6. \_\_\_\_\_ 7. \_\_\_\_\_ 8. \_\_\_\_\_ 9. \_\_\_\_\_ 10. \_\_\_\_\_

IF YOU HAVE MORE PROGRAMS THAN ABOVE, PLEASE USE A SEPRATE SHEET

DO YOU AGREE TO ABIDE BY CLUB RULES? \_\_\_\_\_ WILL YOU KEEP CLUB CONFIDENCES? \_\_\_\_\_

MEMBERSHIP FEE OF \$30.00 MUST ACOMPANY THIS APPLICATION

(\$50.00 (Surface) \$90.00 (Airmail) Outside the U.S.A.)

Payment Enclosed

Charge  VISA  MasterCard



My Account # \_\_\_\_\_ Interbank # (MC only) \_\_\_\_\_

Signature \_\_\_\_\_ Card Expiration Date \_\_\_\_\_

SIGNATURE \_\_\_\_\_ PAGE 79



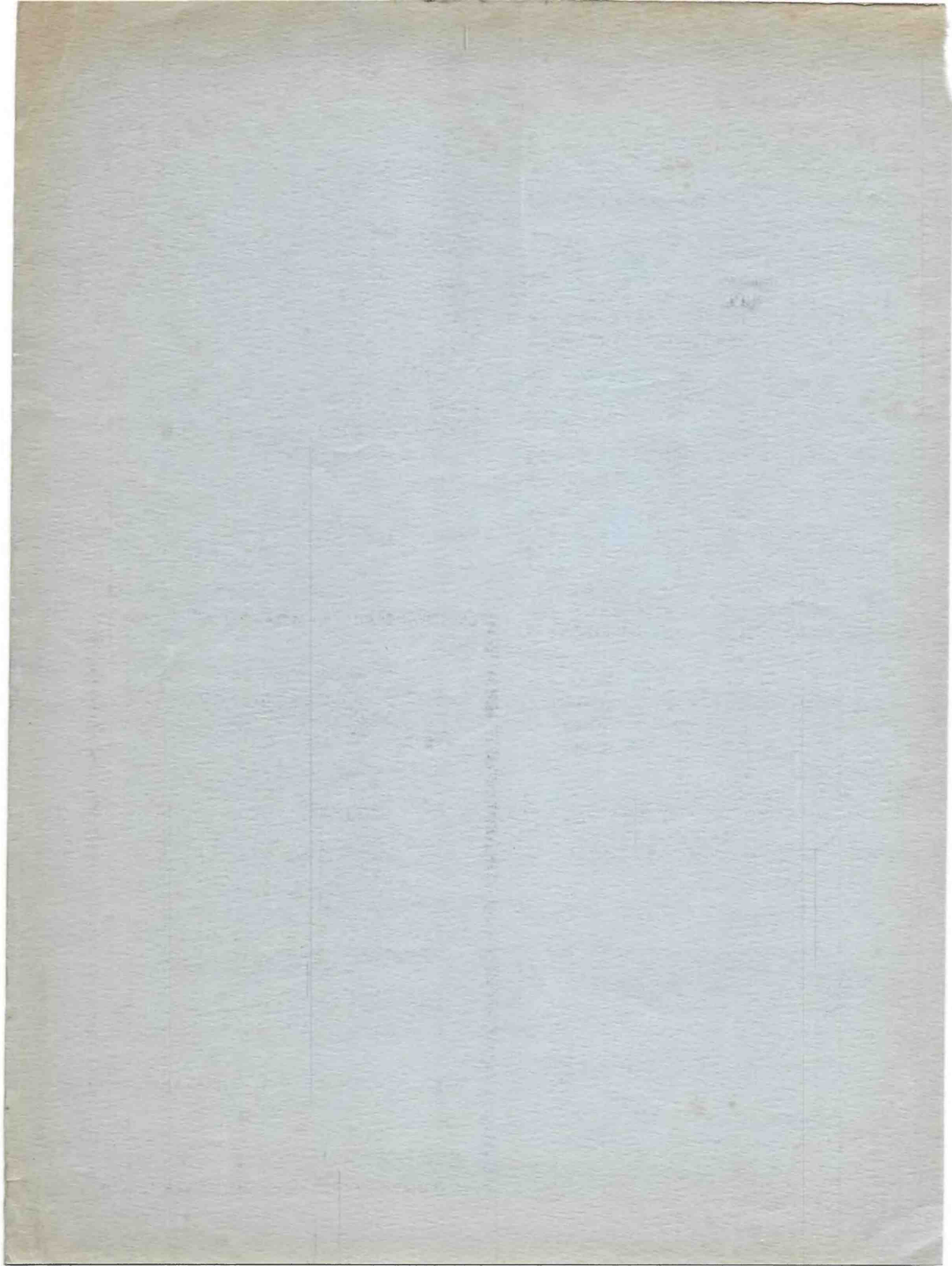

International  
Color Computer Club, Inc.

2101 E. Main St.

Henderson, Texas 75652

BULK RATE  
U. S. POSTAGE  
PAID  
Henderson, Texas  
PERMIT No. 130

Return Postage Guarantee

Address Correction Requested

---